



USER MANUAL

HS928 MOBILITY SCOOTER
MAXI



TABLE OF CONTENTS

INTRODUCTION	1
IMPORTANT PRECAUTIONS	2
ELECTROMAGNETIC INTERFERENCE AND WARNINGS	3
SAFETY WARNING & INSTRUCTION LABELS	5
IDENTIFICATION OF PARTS	6
CHARGING THE BATTERIES	12
DISASSEMBLING YOUR SCOOTER	14
LCD DISPLAY PANEL	16
CAUTION	27
CARE AND MAINTENANCE	28
TECHNICAL SPECIFICATIONS	30

INTRODUCTION

Thank you and congratulations on purchasing your new Aspire mobility scooter.

It is designed to provide the transportation ability indoors and outdoors for person whose ability to walk is impaired, but who are still in terms of their eyesight and physically and mentally able to operate an electric scooter.

We pride ourselves on providing safe and comfortable products. Our goal is to ensure your complete satisfaction. We sincerely hope you enjoy your Aspire mobility scooter.

Please read and observe all warnings and instructions provided in owner's manual before you operate the various functions of this scooter. Also, please retain this booklet for future reference.

MANUFACTURED AND IMPORTED BY:

AIDACARE PTY LTD.

Building 3A, 1 Moorebank Avenue,
Moorebank NSW Australia 2170
1300 133 120 | www.aspirecare.com.au

IMPORTANT PRECAUTIONS

- Only one person at a time could ride an Aspire Mobility Scooter.
- Maximum load : HS-928 is 226 kg.
- Turn key off before getting on or off.
- Always drive carefully and be aware of others using the same area.
- Always use pedestrian crossings wherever possible. Take extreme care when crossing roads.
- Do not drive on slope exceeding 9 degree, and take extreme care when turning on slope.
- Do not use full power when turning to sharp corner.
- Take great care and drive in low speed when backing up, riding downhill or on uneven surface, and climbing curb.
- A slow speed must always be used when descending or traversing a slope or incline and also on uneven terrain, ramps and soft or loose surfaces, such as gravel or grass. If the speed is too fast, leave your hand off the handle bar, let the scooter stop. Make sure safety and start again.
- The weight capacity limit at different ramp degree (please refer to following picture).

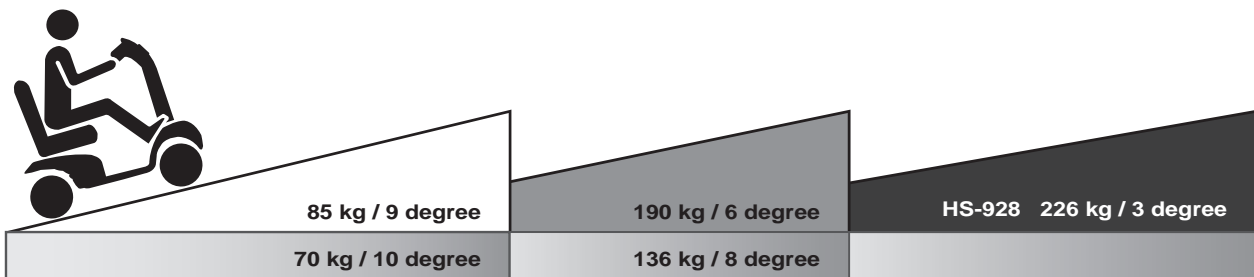

- The grade climbing degree will be affected by weight capacity, driving speed, and ramp degree, and scooter parameter.
- To prevent any danger from motor defected; please avoid to drive on long ramp or any uneven terrain.

- The batteries voltage normally will go up when driving on descending road. If the battery voltage becomes too high, the over-voltage protection will be activated by slowing the speed till the scooter stops. (error code :ERR3 will be displaying). Please pull over the scooter to the safe area, release the wigwags and restart the scooter again.
- To prevent any danger, do not turn around at high speed on ascending, descending ramp. Stopping distance is much longer on a downhill slope than on even terrain.
- Scooter may not operate well in high humidity.
- Do not leave the powered scooter in a rain storm of any kind.
- Do not use the powered scooter in a shower.
- Direct exposure to rain or dampness will cause the scooter to malfunction electrically and mechanically; may cause the powered scooter to prematurely rust.
- Never put scooter in neutral when staying on slopes.
- Follow traffic laws when riding outside. Do not drive your scooter if you are under the influence of alcohol or medication that may affect your ability.
- When scooter on moving transport vehicles, do not sit or stay on scooter.

ELECTROMAGNETIC INTERFERENCE AND WARNINGS

CAUTION: It is very important that you read this information regarding the possible effects of Electromagnetic Interference on your motorized scooter.

Powered wheelchairs and motorized scooters may be susceptible to electromagnetic interference (EMI), which is interfering electromagnetic energy (EM) emitted from sources such as radio stations, TV stations, amateur radio (HAM) transmitters, two-way radios, and cellular phones. The interference (from radio wave sources) can cause the motorized scooter to release its brakes, move by itself, or move in unintended directions. It can also permanently damage the motorized scooter control system. The intensity of the interfering EM energy can be measured in volts per meter (V/m). Each motorized scooter can resist EMI up to a certain intensity. This is called its "immunity level." The higher the immunity level, the greater the protection. At this time, current technology is capable of achieving at least a 20 V/m immunity level, which would provide useful protection from the more common sources of radiated EMI. The immunity level of this motorized scooter model is not known.

There are a number of sources of relatively intense electromagnetic fields in the everyday environment. Some of these sources are obvious and easy to avoid. Others are not apparent and exposure is unavoidable. However, we believe that by following the warnings listed below, your risk to EMI will be minimized.

The sources of radiated EMI can be broadly classified into three types :

1. Hand-held portable transceivers (transmitters-receivers) with the antenna mounted directly on the transmitting unit. Examples include: citizens band (CB) radios, "walkie talkie," security, fire, and police transceivers, cellular telephones, and other personal communication devices



Some cellular telephones and similar devices transmit signals while they are ON, even when not being used

2. Medium-range mobile transceivers, such as those used in police cars, fire trucks, ambulances, and taxis. These usually have the antenna mounted on the outside of the vehicle; and
3. Long-range transmitters and transceivers such as commercial broadcast transmitters (radio and TV broadcast antenna towers) and amateur (HAM) radios



Other types of hand-held devices, such as cordless phones, laptop computers, AM/FM radios, TV sets, CD players, and cassette players, and small appliances, such as electric shavers and hair dryers, so far as we know, are not likely to cause EMI problems to your motorized scooter.

Motorized Scooter Electromagnetic Interference :

Because EM energy rapidly becomes more intense as one moves closer to the transmitting antenna (source), the EM fields from hand-held radio wave sources (transceivers) are of special concern. It is possible to unintentionally bring high levels of EM energy very close to the motorized scooter control system while using these devices. This can affect motorized scooter movement and braking. Therefore, the warnings listed below are recommended to prevent possible interference with the control system of the motorized scooter.

Warnings :

Electromagnetic interference (EMI) from sources such as radio and TV stations, amateur radio (HAM) transmitters, two-way radios, and cellular phones can affect motorized scooters. Following the warnings listed below should reduce the chance of unintended brake release or motorized scooter movement which could result in serious injury.

1. Do not operate hand-held transceivers (transmitters-receivers), such as citizens band (CB) radios, or turn ON personal communication devices, such as cellular phones, while the motorized scooter is turned ON;
2. Be aware of nearby transmitters, such as radio or TV stations, and try to avoid coming close to them;
3. If unintended movement or brake release occurs, turn the motorized scooter OFF as soon as it is safe;
4. Be aware that adding accessories or components, or modifying the motorized scooter, may make it more susceptible to EMI; and



There is no easy way to evaluate their effect on the overall immunity of the motorized scooter.









5. Report all incidents of unintended movement or brake release to the distributor listed on the inside front cover of this manual. Note whether there is a source of EMI nearby.

Important Information :

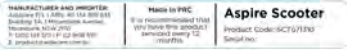
1. 20 volts per meter (V/m) is a generally achievable and useful immunity level against EMI (as of May 1994). The higher the level, the greater the protection.
2. The immunity level of this product is at least 20/Vm.

SAFETY WARNING & INSTRUCTION LABELS

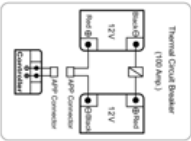
The following labels are positioned on your scooter, they communicate important warnings or instructions regarding the safe operation of your scooter. Please carefully read all labels before driving.

	<ol style="list-style-type: none"> 1. Please read the instruction booklet carefully before using your scooter. 2. Do not drive the scooter on slippery surfaces or on slopes over 8 degree. 3. Do not drive on highway, crowded roads, or unfamiliar areas. 4. Do not turn at high speed in either forward or reverse. 5. Do not wash with water or leave scooter in humid nvironment since water can damage the electronic parts.
	<p>Do not hang baggage or other objects on the tiller / tiller adjustment lever.</p>
	<p>Information Sticker states the date of manufacture and serial number of the scooter. This product has been supplied from an environmentally aware manufacturer. It may contain substances that could be harmful to the environment. Recycling must be carried out in accordance with the respective national legal provisions.</p>
	<p>Tiller angle adjustment.</p>
	<p>N-D Lever Adjustment label which instructs freewheel mode operation.</p>
	<p>Tie-down points of the scooter. Do not sit or stay on the scooter during transporting.</p>
	<p>Wiring diagram Label</p>
	<p>Ensure your hands are away from any moving parts before activating the door.</p>
	<p>The DC 24/2A port is for LED reading light use ONLY. Do not use the port to charge scooter or any other devices.</p>

IDENTIFICATION OF PARTS

Before you take your first trip, you should familiarize yourself well with the operation of the scooter and with all operating elements. Take your time to test all functions and driving modes.



Figure 1 - HS-928 Front View

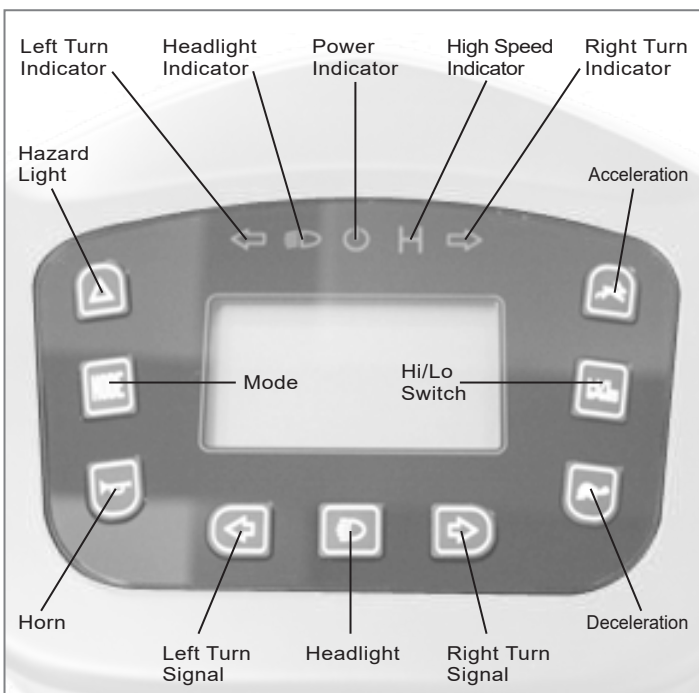

Figure 2 - HS-928 Control Panel

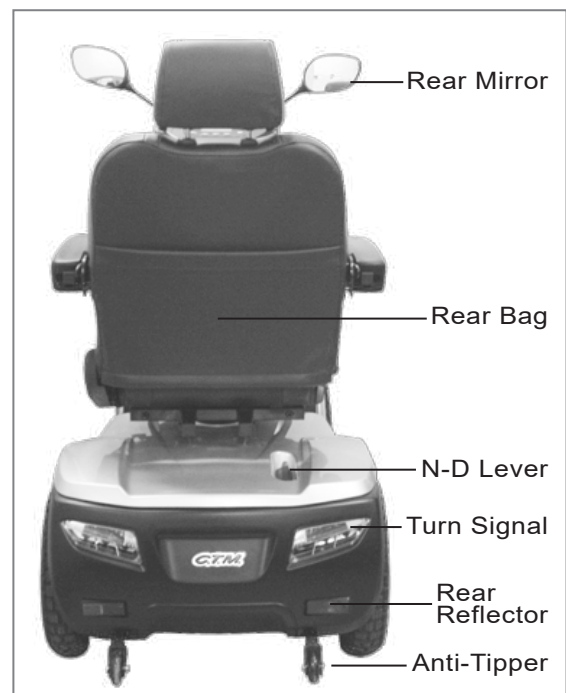



Figure 3 - HS-928 Rear View

FUNCTION OF PARTS :

Main Key Switch (A)

1. Turn the key to the right - Turn the scooter on
2. Turn the key to the left - Turn the scooter off

 **Always ensure that the scooter is switched off before getting on or off the scooter and before removing any items of the scooter**

 **Turning the scooter OFF whilst driving will bring the scooter to an abrupt stop and danger.**







Figure 4

TOP CONTROL PANEL

 **Hazard Light (B)** : Switch on by pressing once, switch off by pressing again. Press hazard light button once, the right/left lights and parking indicator start to flash, warning tone acts as well; If the Hazard lights are activated, with the key switched to the on position, the lights will continue to flash even when the key is switched off. The Hazard light button should be depressed to cancel the flashing.

 **Mode (C)** : Change mode by pressing once

-  a. Clock
-  b. Temperature
-  c. Speedometer
-  d. ODO
-  e. Trip Meter

 **Horn (D)** : Press horn button once to sound warning tone when necessary.

 **Left Turn Signal (E)** : Press Left Turn Signal button once, the front and rear left turn indicators start to flash, and warning tone sounds simultaneously; press button again to switch off the turn indicators/signal and tone.

 **Right Turn Signal (G)** : Press Right Turn Signal button once, the front and rear right turn indicators start to flash, and warning tone sounds simultaneously; press button again to switch off the turn indicators/signal and tone.

※Right-hand/Left hand direction indicator (switches itself off automatically after 30 seconds).

 **Headlight (F)** : Press headlight button once to switch on, switch off by pressing again.

 **Acceleration (H)** : Press acceleration button once to increase speed, fine tune in 1'5 speeds.

 **Deceleration (J)** : Press acceleration button once to decrease speed, fine tune in 1'5 speeds.

 **Hi/Lo Switch (I)** : Press H/L Speed button once, the High/Low Speed Indicator will light on, means driving in high speed mode; Press again, the indicator will extinguish means driving in low speed mode.

(Hi/Lo speed will vary depend on your current speed settings)



Figure 5

Tiller Storage Compartment (K) Provide you a spacious room to put things.
Hand Brake (L). Hold brake (L), when immediate stop is required.

 **If you have to brake in an emergency, simply release the Throttle and hold hand brake, which will bring you to a halt!**

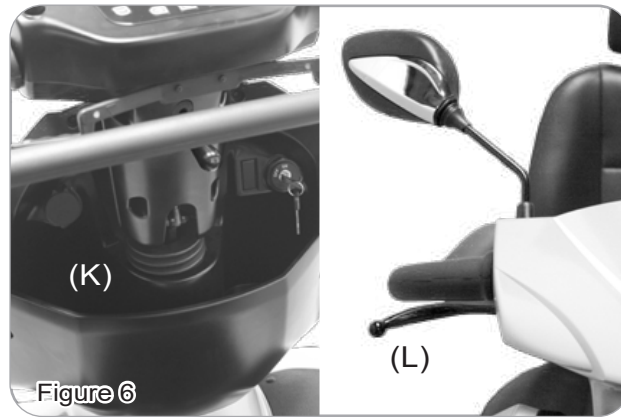

Wigwag Lever Operation

Pull the left-hand drive lever (M) carefully to travel forwards.

Pull the right-hand drive lever (N) carefully to travel in reverse.

(This can be reversed if required by local dealer.) Releasing both, engages automatic brake. These are also your accelerator. The further you depress them, the faster you go. (Subject to the position of the Rabbit / Turtle control).

 **Keep LCD display panel and Wigwag Lever dry, if panel and Wigwag Lever get wet, allow to dry out before using.**

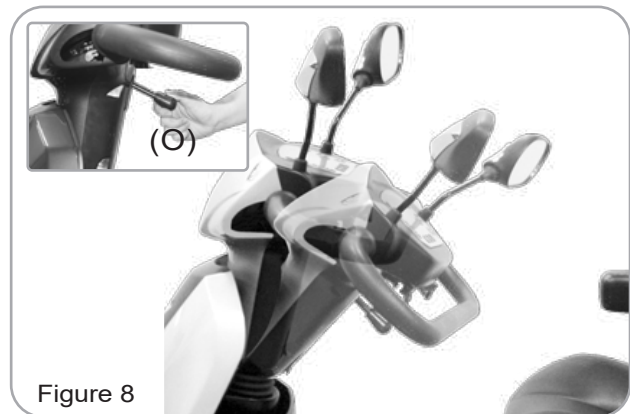
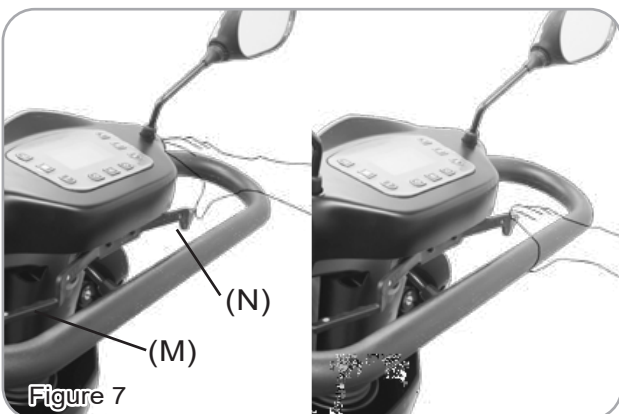

Steering Adjustment

By pressing angle adjustment (O) down to adjust to any comfortable angles.

 **Adjust angle adjustment while driving is prohibited. Adjust steering to the foremost position before and after getting on the scooter.**

Seat Fore-Aft Adjustment (P)

Pull the Seat fore-aft Adj Lever (Q) to disengage the seat (P). Slide the seat forwards or backwards into the required position. Let go of the lever (Q) again to lock the seat into its required position.

 **When driving the scooter, set the seat (P) at foremost position to prevent tip over.**

 **Sit firmly on seat after getting on the scooter, do not stand on the foot rest to prevent tipping over or damaging to the scooter.**

Angle Armrest Adjustment (R).

Pull the lever (S) and adjust the armrest to the required angle.

 **Pull the armrest up when get on or off the scooter. Do not hang heavy parts on the armrests to cause tip over.**

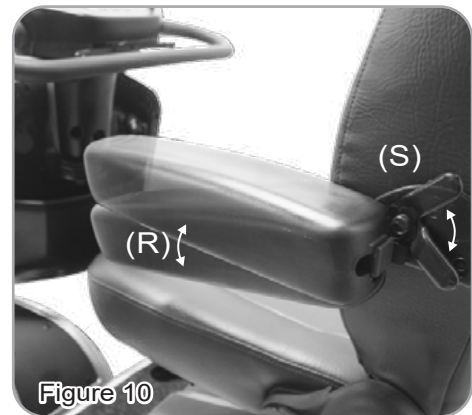

Seat Swivel Adjustment

Pull the lever (T) upwards to disengage and rotate seat (P) to required angle, Let go of the lever (T) to lock the seat into its required position. Please try to avoid non-essential seat swivel adjustment for HS-928C.

Seat Back Angle Adjustment

Pull the lever (U) upwards to adjust backrest's angle, then release the lever when adjusted to required position.

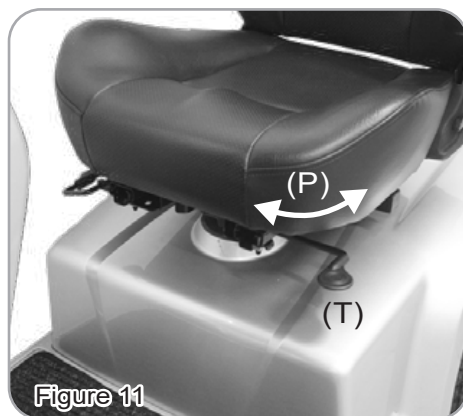



 **For safety reasons the backrest's position must remain vertical before driving.**

Seat (P) Height Adjustment

- 1.Refer to page 14 for disassembly, then remove seat (P) and rear shroud (Z). (Figs 20 & 21)
- 2.Remove screw, nut and washer from seat post (V). (Fig 13)
- 3.Adjust seat post (V) to desired height, and attached tightly with screw, nut and washers. (Fig 13)
- 4.Then assemble the rear shroud (Z), seat (P) back to its original position. (Fig 20 & 21)

Seat (P) Electrical Lifter (Optional)

- 1.Press seat lifter button  (W) lightly, seat will raise.
press  lightly, seat will lower.

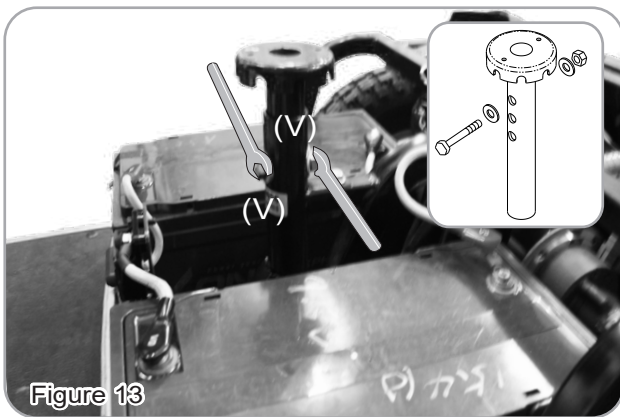

Figure 13

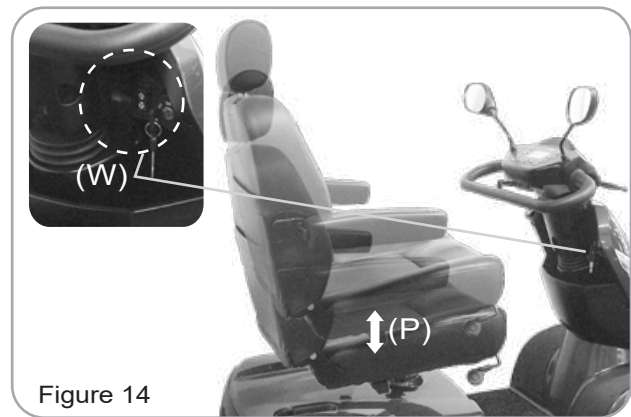

Figure 14



- Do not operate this function on a slope, or in motion or under unstable condition.
- The main purpose of this function is to assist you to reach certain height.
- Seat's position must remain at the lowest before driving.
- Do not set N-D lever at N, before setting the seat at lowest position.
- Please keep the center of gravity of the scooter in the middle, to prevent the scooter tipping over.

N-D Lever Adjustment :

- 1.When scooter stopped or malfunction, press the unlocking knob on the N-D lever (X). Push the N-D lever forwards this will allow you to push the scooter by hand.



Freewheel operation is only recommended on flat surfaces, never on gradients. Never leave your scooter on a gradient with its motors disengaged. Always re-engage the motors immediately after pushing the scooter.



The scooter won't operate, if the scooter is setting at N position, to restore to it's normal status, you must switch the power off and adjust to D position, then switch the power on.

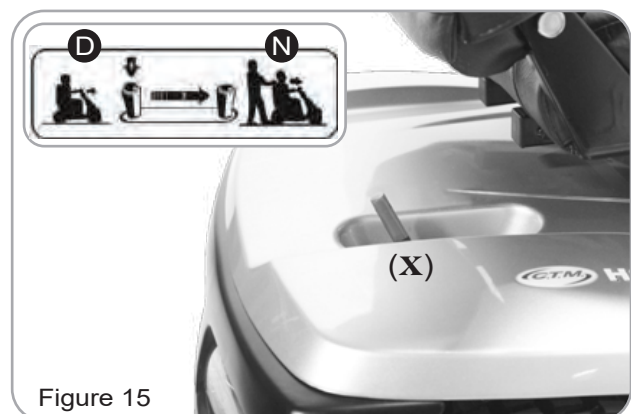

Figure 15

Proportional Speed Reduction :

- 1.The scooter is equipped with proportional speed reduction. It will automatically reduce speed when encountering a corner, reducing speed corresponding to the angle of turn.
- 2.For safety reasons, when pushing the scooter by hand, if a pre-determined speed is exceeded, the controller automatically switches on and brakes the scooter.



Avoid shifting your center of gravity as well as abrupt changes of direction when the scooter is in motion.



Reduce speed before negotiating corners! Only accelerate when you have come out of the corner!

Tie - Down Hook :

To enable you to transport your scooter safely and securely there are 2 additional tie down hooks located on the underside of the scooter. (Fig 16)



When fixed on a transportation system, N-D lever (X) must located at D position. This scooter must not be occupied or used as a seat in a motor vehicle whilst being transported.

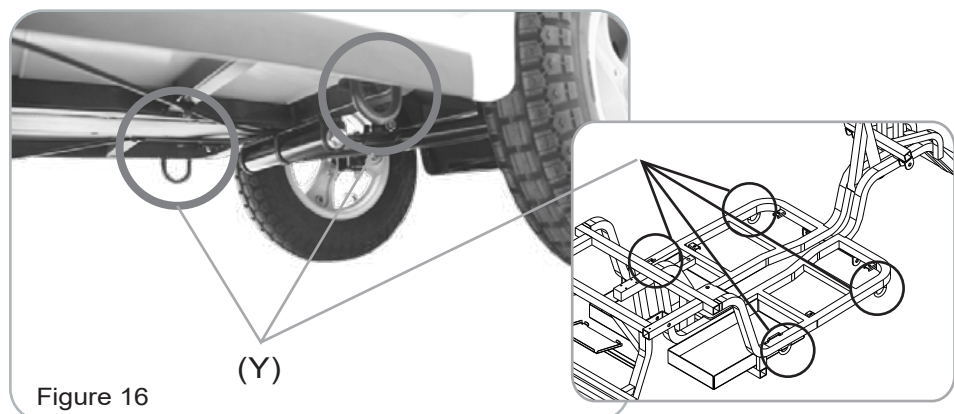

CHARGING THE BATTERIES

Batteries must be charged before using the scooter for the first time and should be recharged after each day use. You will need the scooter and the battery charger. Battery charger are available in 8A / 12A, depends on the sizes of batteries and model of the scooter.



Each country may supply different charger. The charging procedure may be different from below. If you require more details, please contact your authorized dealer. Be sure the scooter key is in the OFF position before charging.

8A/12A Charger for HS-915/928 :

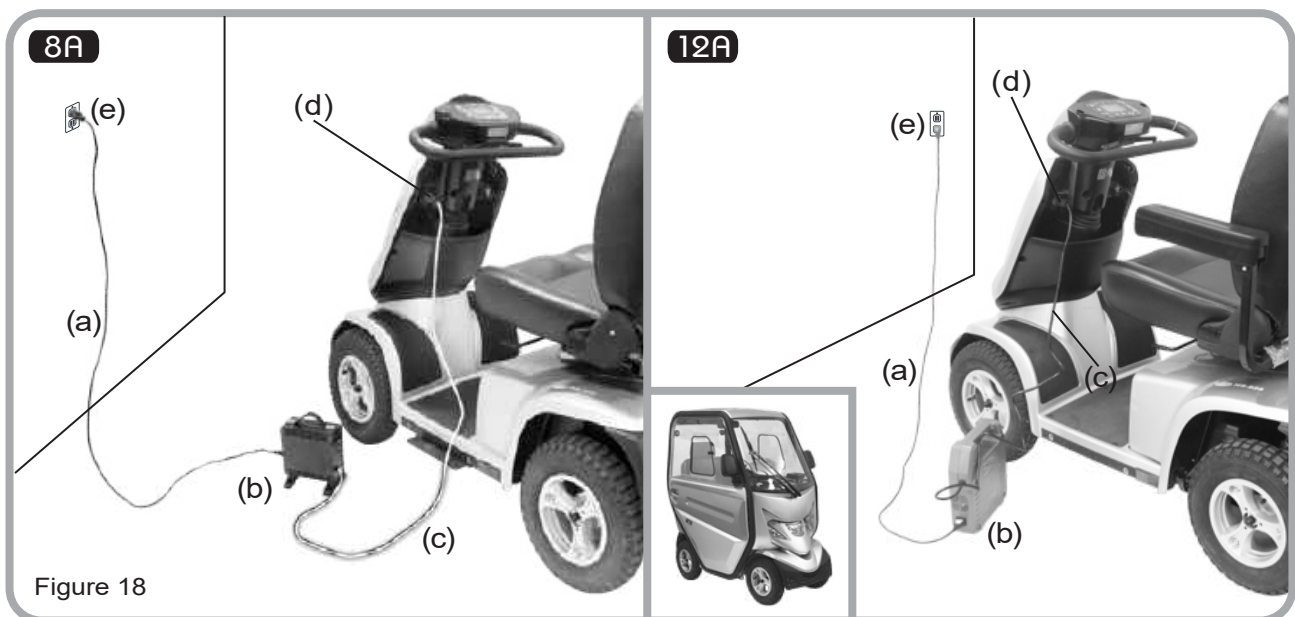

Figure 18

Operating Instruction

1. Make sure the power cord (a), charger (b), charging cable (c) are in good condition.
2. Make sure the output voltage of charger is the same as the connecting battery / scooter.
3. Connect the connector of charging cable (c) to the charging socket (d).
 Plug In : Follow the index pin to plug in the connector.
 Unplug : Unplug the charging cable (c) from the socket.
4. Make sure the AC voltage is correct and plug in the power cord to power socket (e), the Charge LED light on the charger will turn on to yellow (12A), orange (8A) when it is in charging.
5. The Charge LED light on the charger will turn on to green when the battery / scooter is fully-charged.

LED Indication

12A

⊙Power on : On/off LED - Yellow light on

⊙Charge on :

- Charge LED - Yellow light on = Normal charging
- Green light flashing = 80% fully charged.
- Green light on = Fully charged
- Yellow light flashing = No batteries or incorrect batteries fitted
- Red light on / flashing = Faulty

8A

⊙Power on : On/off LED - Green light flashing

⊙Charge on :

- Charge LED - Orange light Flashing = Pre-charge
- Orange light on = Normal charging
- Green & Orange light flashing = 80% fully charged.
- Green light on = Fully charged
- Red light flashing = Faulty

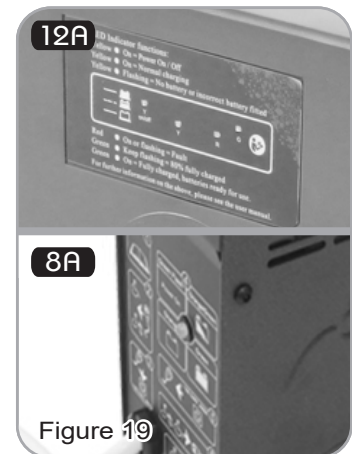

Figure 19



The time needed to recharge will vary depending on the depletion of the batteries. (Approx. 8 hours). Do not continuous charging for over 15 hours.

Troubles Shooting

1. Charge LED light is off
Check to see if the connectors are well connected.
2. Power LED light is off
Check to see if the input power cord has been connected correctly.
3. If the Red light flash in charging, it means the charger cannot charge normally and enter into protection mode. Please unplug the power cord, and plug in again when the light is off.



Maintenance & Repair must only be carried out by a Competent Engineer or Authorised Dealer or Agent.

Warning

- Only be used for 12V lead-acid battery, and do not used for other type of battery or other voltage.

Keep in mind these rules :

- Fully charge batteries at least once a month, or more if you use scooter regularly. Charge after each trip exceeding 3 kilometers.
- If storing your scooter for some time (1 month or more), make sure that batteries are fully charged, and on returning, charge them again before using scooter.
- Batteries will only give maximum performance after scooter has been used, and batteries have been recharged up to 10 times. A bit like breaking in a new car.

Please be aware that the travelling range of your mobility scooter is impacted by how fast the batteries are discharged. This will depend on many circumstances, such as ambient temperature, condition of the surface of the road, tyre pressure, weight of the driver, driving environment (inclines etc.) and utilisation of your lighting system if fitted. We recommend that you test your local ride with a family member to ensure a safe journey.

DISASSEMBLING YOUR SCOOTER

Seat (P) disassembling :

Pull the lever (T) upwards to disengage the seat (P), hold the seat (P) firmly by the backrest and front edge and remove it upwards.



If found the seat (P) uneasy to remove, hold seat swivel lever (R), and then rotate the seat to reduce resistance then pull up.

Proceed with caution, if you need assistance, please have some one to help you

Rear Shroud (Z) and Batteries (C1) Disassembling :

- 1.Remove rear shroud (Z) upwards. (Figure 20)
- 2.Unplug one battery connector (A1) (Figure 21)
- 3.Release Velcro (B1) (Figure 22)
- 4.Remove two batteries (C1) (Figure 23)



Take into account the heavy weight of the batteries (C1) please consider your physical condition before disassembling.

DO NOT short-circuit battery connector (C1).

Battery's red wire plug connects to red positive location, black wire plug connects to black negative location.

For safety reason, please wash your hands after disassembly.

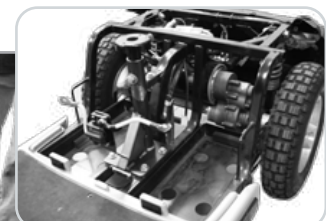
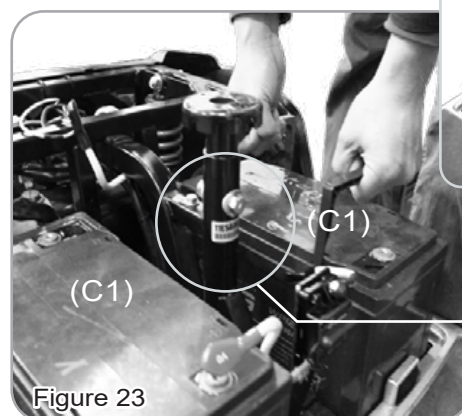
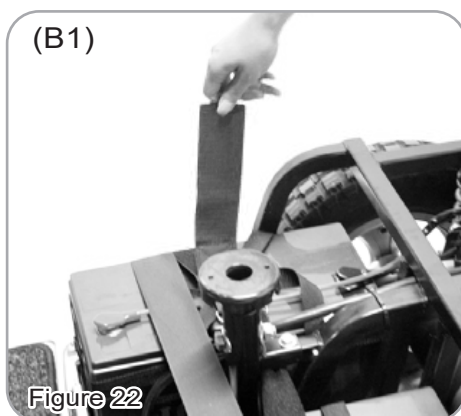
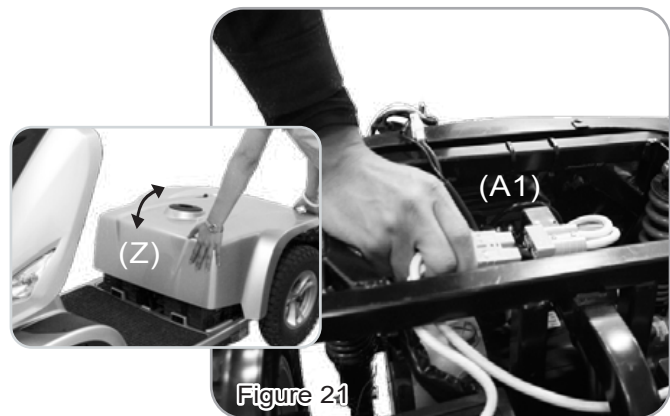
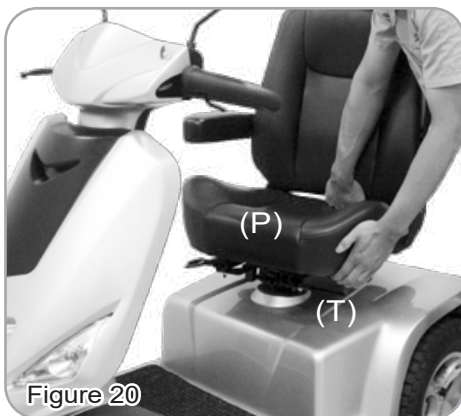

Information sticker of scooter

Resetting the Circuit Breaker :

Resetting the circuit breaker may be needed if scooter does not turn on and when a scooter's circuit over loaded, the circuit breaker will trip.

- 1.To reset, press the circuit breaker button (D1) upwards.
- 2.Reassemble the rear shroud (Z).
- 3.Reassemble the seat.

If the circuit breaker trips repeatedly, IMMEDIATELY unplug charger and contact dealer or a qualified technician.



NEVER defeat or bypass the circuit breaker.
ONLY replace with a circuit breaker of the same rating.

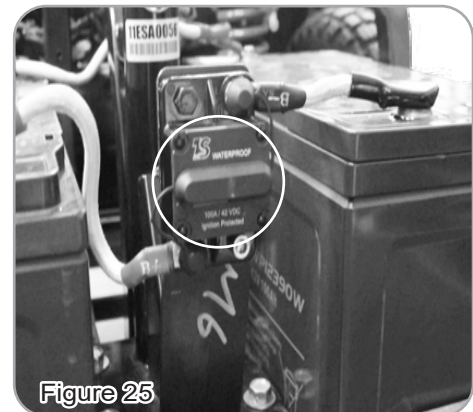
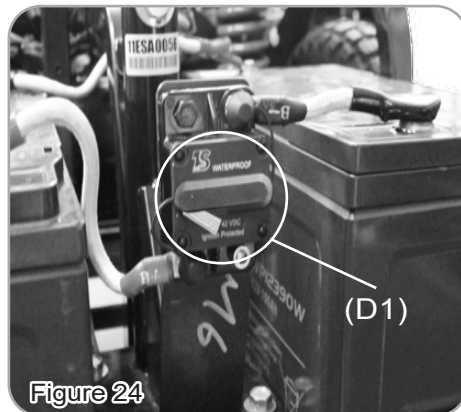

LCD DISPLAY PANEL



Function Buttons & Indicators

ITEM	SPECIFICATION
Control Buttons	Hazard Light, Horn, Right Turn Light, Headlight, Left Turn Light, Turtle(decelerate), H/L Speed, Rabbit(accelerate)
LED Indicators	Status Indicator (Green) Headlight Indicator (Green) Left / Right Indicators (Green) High/Low Speed Indicator (Green)
Connector	20PIN
LCD Back Light	Blue LEDs illuminate while key on.

Function Descriptions

FUNCTION	SPECIFICATION
1.Full Lighting Control	Headlight , Taillight, Left/Right Turn Signal, Hazard Light, Brake Light
2.Speedometer	7 Segment display (2 1/2 digits +1 decimal) "km/h" and "mph" symbol
3.Digital High / Low Speed Control	Low (L) Speed: 1 - 5 Rate High (H) Speed: 1 - 5 Rate
4.Power Indicator	Battery discharge and charging indicator (6 segments)
5.Malfunction Messages	Error code: 1~7 (1 digit) + LED Indicator
6.Key On Display	LCD full segments display
7.Warning Tone Setup	Volume adjustment for tones of Left/Right turn light, Parking light, Low voltage warning and horn

1.Full Lighting Control

Headlight, Taillight

ITEM	SPECIFICATION
Operation Feature	Take exterior headlight switch as determinant signal.
Control Mode	Press button to turn on headlight & turn signal and headlight indicator. Press button again to turn off headlight & turn signal and headlight indicator.
Usage Condition	While (1) controller shut down (2) on power-saving mode, all functions closed.
Remarks	(1) Loop Load of Headlight : 12V/50W Max (2) Loop Load of Taillight : 24V/50W Max (3) With "short circuit" and "overload" protection

Brake Light

ITEM	SPECIFICATION
Operation Feature	Take accelerator & manual brake as determinant signal.
Control Mode	While (1)accelerator is moved from Forward to Center position, (2)accelerator is moved from Backward to Center position or (3>manual brake is operated, the vehicle is considered to brake. The brake light will be lit After 5 seconds, the light will switch off automatically.
Usage Condition	While (1) controller shut down (2) on power-saving mode, all functions closed.
Remarks	(1) Loop Load of Brake light: 24V/50W Max (2) With "short circuit" and "overload" protection

Turn Light and Parking Lights

ITEM	DESCRIPTIONS
(Control Mode) Left Turn Light	Press left-indicator button once, the left light and left indicator starts to flash, and warning tone sounds simultaneously; press button again to switch off the indicator/light and tone.
Right Turn Light	Press right-indicator button once, the right light and right indicator starts to flash, and warning tone sounds simultaneously; press button again to switch off the indicator/light and tone.

Automatic Turn Off	The direction lights and indicators will be turned off automatically while flashing for 30 seconds.
Hazard Lights	Press hazard indicator button once, the right/left lights and hazard indicator start to flash, warning tone acts as well; press button again will turn off above indicators and tone. To activate the parking lights while KEY ON, the lights would keep flashing even KEY OFF.
Determinant Condition	There is no priority between left / right lights or parking lights.
Usage Condition	While (1) controller shut down (2) in charging-mode, the function will be disabled.
Flicker Frequency	1 second, Duty 50%
Warning Tone Frequency	1 second, Duty 30%
Remarks	(1)Load circuit for left turn light: 24V/50W max (2)Load circuit for right turn light: 24V/50W max (3)With "short circuit" and "overload" protection (4)The volume of warning tones for left/right turn lights, parking lights could be adjusted.

2.Mode

2-1 Clock

ITEM	DESCRIPTIONS
Timekeeping error per day	± 2 seconds
Initial Display	「 HH 」 「 MM 」 Mode : 「 AM 12:00 」
Time Format (12 hours- AM/PM)	<p>Press 「 Mode 」 button and switch to Clock mode.</p>  <p>Display range : AM12:00 ~ PM11:59</p> <p>HH display : The "0 of ten's digit is invisible from 10' clock to 90' clock.</p>

<p>Setup Mode (Time adjustment)</p>	<p>Press + together for 3 secs to enter setup mode.</p> <p>While 「HH」 is flashing, Press to increase digits and to decrease digits. Press 「Mode」 to enter 「MM」 setup mode when finished.</p> <p>While 「MM」 is flashing, Press to increase digits and to decrease digits. Press 「Mode」 to return 「HH」 setup mode when finished.</p> <p>Press () once to increase (decrease) one digit. The digits can increase (decrease) accumulating when press the buttons more than 2 secs. The display is cycling. It takes 2 secs to increase from 0 to 9 for each position.</p>
<p>Quit Setup Mode</p>	<p>The user could quit the setup mode with the following conditions.</p> <p>(1) Leave or buttons alone for 15secs. (2) Press any button of Parking light, Horn, Turn light or Headlight, the definitive settings will be stored and return to normal clock mode.</p>

2-2 Thermometer

ITEM	DESCRIPTIONS
<p>Operation Feature</p>	<p>Use thermistor (NTC) to detect the signal and transfers to related temperature.</p>
<p>Display Errors</p>	<p>± 2°C</p>
<p>Operational Mode of Thermometer</p>	<p>Press 「Mode」 button and switch to thermometer mode</p> <div data-bbox="668 1357 1177 1637" data-label="Image"> </div> <p>Display range : Centigrade -20~50°C or Fahrenheit -4~122°F</p>
<p>Setup Mode (Unit change)</p>	<p>Press + together for 3 secs to enter setup mode. While 「°C」 / (「°F」) is flashing, press or to switch to 「°F」 / (「°C」)</p>
<p>Quit Setup Mode</p>	<p>The user could quit the setup mode with the following conditions.</p> <p>(1) Leave or buttons alone for 15secs. (2) Press any button of Parking light, Horn, Turn signal or Headlight, the definitive settings will be stored and return to normal thermometer mode.</p>

2-3 Speedometer

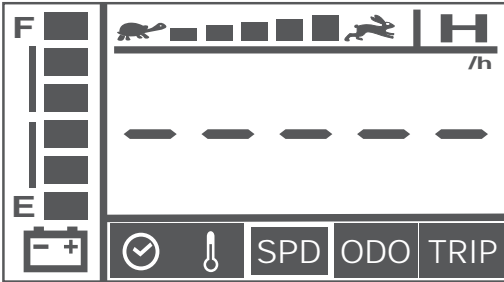
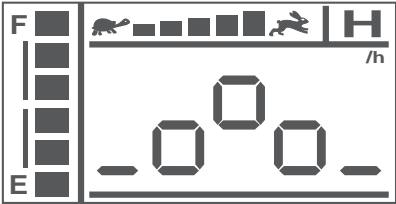
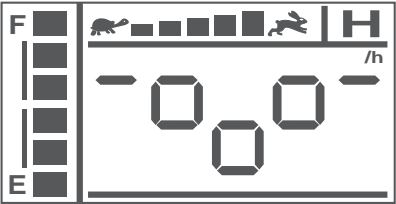
ITEM	DESCRIPTIONS
Operation Feature	Use optical coupler to detect the signal and transfer to related speed. Speed displays 60km/h while it's on 1500 rpm.
Display Errors	+15~20%
Display Range Operational mode of speedometer	0.0 ~ 30.0, display resolution: 0.5 Press 「 Mode 」 button and switch to speedometer  <p>When "km/h" is displayed, speed will be indicated in km per hour.</p> <p>When "MPH" is displayed, speed will be indicated in miles per hour.</p> <p>When "/h" is displayed, the function of speedometer will be disable. (This display will be applied to the model that is not equipped with optical coupler) And the display will be replaced to WIP(accelerator) operation indicator as follows:</p> <p>Standby Indication</p>  <p>Forward Indication</p>  <p>Backward Indication</p> 
Setup Mode (Unit change)	Press 🐰 + 🐢 together for 3 secs to enter setup mode. While 「 km/h 」 / (「 MPH 」) is flashing, press 🐰 or 🐢 to switch to 「 MPH 」 / (「 km/h 」).

<p>Setup Mode (Unit change)</p>	<p>The user could quit the setup mode with the following conditions. (1) Leave 🐢 or 🐇 buttons alone for 15secs. (2) Press any button of Parking light, Horn, Turn light or Headlight, the definitive settings will be stored and return to normal speedometer mode.</p>
-------------------------------------	---

2-4 Odometer

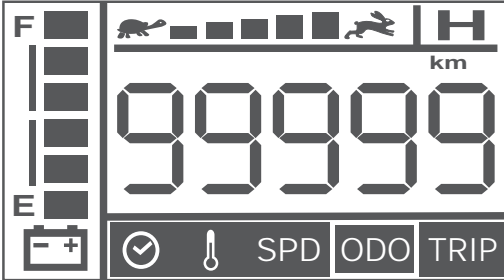
ITEM	DESCRIPTIONS
Operation Feature	Use optical coupler to detect the signal and transfer to related distances.
Unit Switch	When speedometer was set as 「km/h」, the odometer displays as kilometer. 「mph」, the odometer displays as mile. 「/h」, means the odometer is displaying as travel hours.
ODO Mode	Press 「Mode」 button and switch to ODO mode.  <p>Display range : 0~99999 When the total distance goes to 99999km or 62149mile (99999 ÷ 1.609mile), the digits will be reset to zero "0".</p>

2-5 TRIP Mode

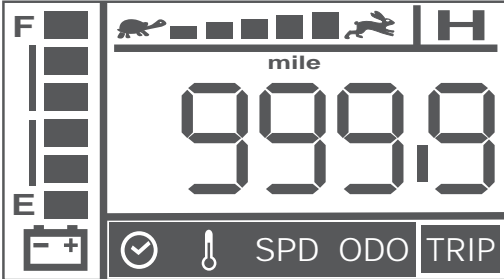
ITEM	DESCRIPTIONS
TRIP Mode	Press 「Mode」 button and switch to TRIP mode.  <p>Display range: 0.0~999.9 When the distance goes to 999.9, the counter will stop.</p>
Reset Mode (Rest TRIP to Zero)	Press 🐇 + 🐢 together for 3 secs to enter setup mode. While 「TRIP」 is flashing, press 「Mode」 for 3 secs to reset to zero "0.0"

Quit Setup Mode	<p>The user could quit the setup mode with the following conditions.</p> <p>(1) Leave 「 Mode 」 button alone for 15secs.</p> <p>(2) Press any button of Parking light, Horn, Turn signal or Headlight, the definitive settings will be stored and return to normal TRIP mode.</p>
-----------------	--

3.Notice to Routine Maintenance for certain mileage

ITEM	DESCRIPTIONS
<p>Display I for Routine Maintenance</p>	<p>The initial mileage of routine maintenance is 5000km</p> <p>Display :</p> <p>When it reaches the mileage for routine maintenance, ODO symbol will start to flash for 1 minute.</p> <p>Time to display :</p> <ol style="list-style-type: none"> when the ODO reaches the mileage for routine maintenance during driving when the ODO reaches the mileage for routine maintenance during Key On  <p>PS.During flashing, the mobility vehicle could be drove normally and the control penal could be operated without any delay.</p>
<p>Display II for Routine Maintenance</p>	<p>After the routine maintenance is finished, the user could setup the mileage for next maintenance. (Count down setting)</p> <p>Setup steps:</p> <ol style="list-style-type: none"> Press 「 Mode 」 button and switch to ODO mode Key off to shut down the controller Press 「 Mode 」 and 「 H/L 」 buttons together Key on to start the controller The display will enter setup mode in 2 secs, the mileage will be flashing. (as Note 1) Press 🐇 or 🐢 button to adjust to the mileage for next maintenance (as Note 2) After setup is finished, press any button of Parking light, Horn, Turn signal or Headlight, the definitive settings will be stored and return to normal working mode. The display will quit to normal working mode while the user does not press or button in 10 secs.

Display II for Routine Maintenance

Note 1 : Setup mode

The mileage counts down to 0km

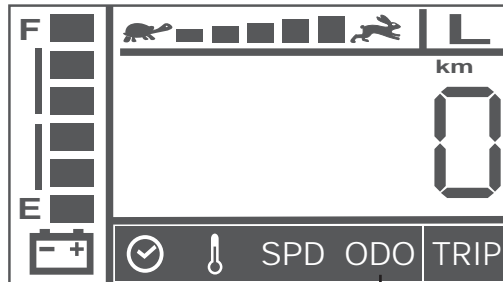

Flashing

The mileage does not count down to 0km.

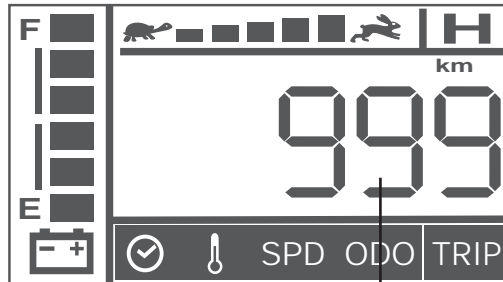

Flashing

















































Note 2

Press or button to adjust to the mileage for next maintenance.



















Press to increase the mileage :
 1000→ 2000→ 3000→ 4000→ 5000→ OFF→ 1000.
 (displays in cycling)

Press to decrease the mileage :
 OFF→ 5000→ 4000→ 3000→ 2000→ 1000→ OFF.
 (displays in cycling)

4. Digital High / Low Speed Control







ITEM	DESCRIPTIONS																		
Operation Feature	Press 「H/L Speed」 button to switch High/Low speed Press  or  to fine tune in 5 speeds																		
Control Mode	Press 「H/L Speed」 button once, the High/Low Speed Indicator (H) will light on. Press again, the indicator will light off. Press  button to increase the speed Press  button to decrease the speed <table border="1" data-bbox="639 663 1203 981"> <thead> <tr> <th>Speed Display</th> <th>H % (Max)</th> <th>L % (Max)</th> </tr> </thead> <tbody> <tr> <td>  </td> <td>20</td> <td>10</td> </tr> <tr> <td>  </td> <td>40</td> <td>20</td> </tr> <tr> <td>  </td> <td>60</td> <td>30</td> </tr> <tr> <td>  </td> <td>80</td> <td>40</td> </tr> <tr> <td>  </td> <td>100</td> <td>50</td> </tr> </tbody> </table>	Speed Display	H % (Max)	L % (Max)	  	20	10	  	40	20	  	60	30	  	80	40	  	100	50
Speed Display	H % (Max)	L % (Max)																	
  	20	10																	
  	40	20																	
  	60	30																	
  	80	40																	
  	100	50																	
Usage Condition	While (1) controller shut down (2) in charging-mode, the function will be disabled.																		

5. Power Indicator

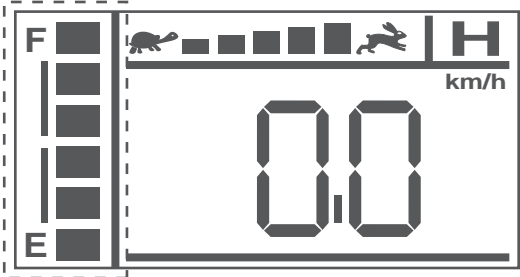
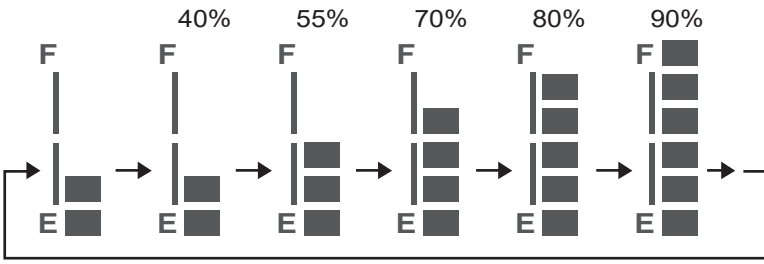
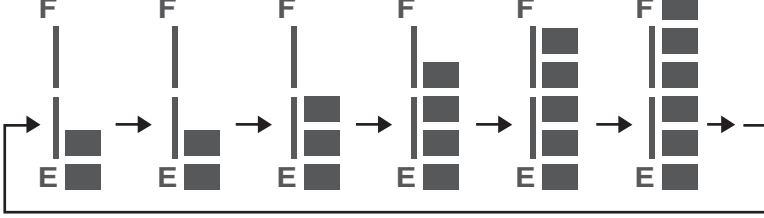
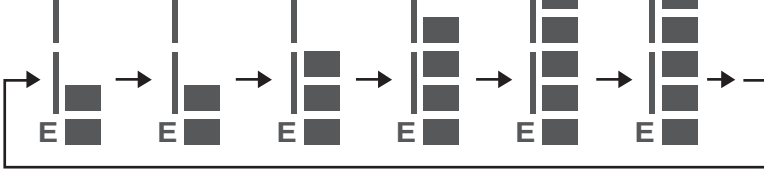
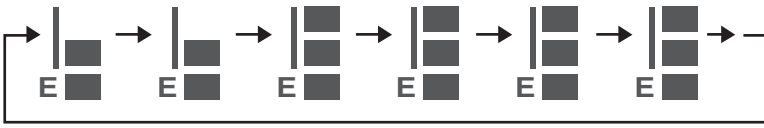

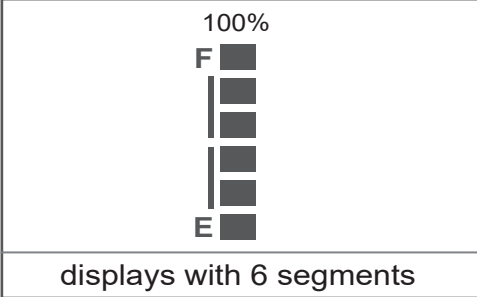
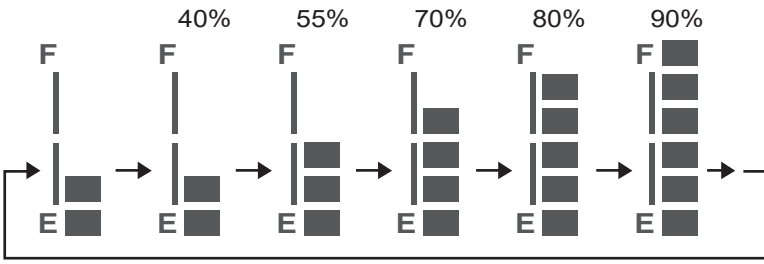
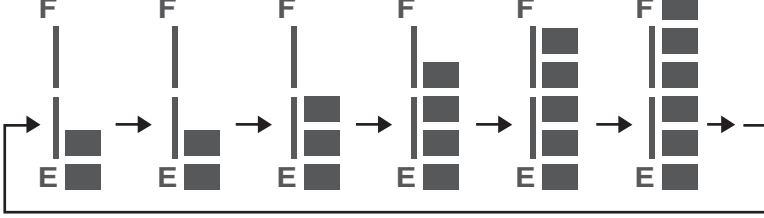
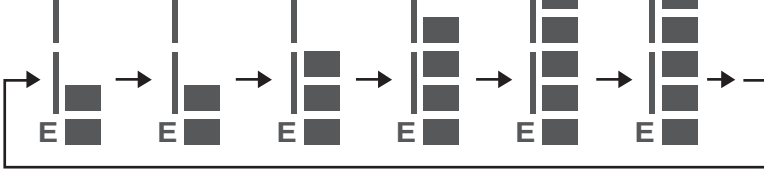
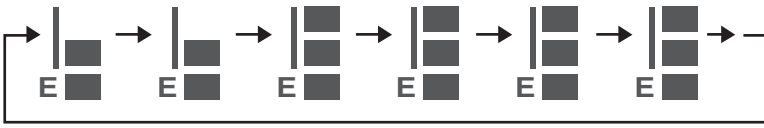

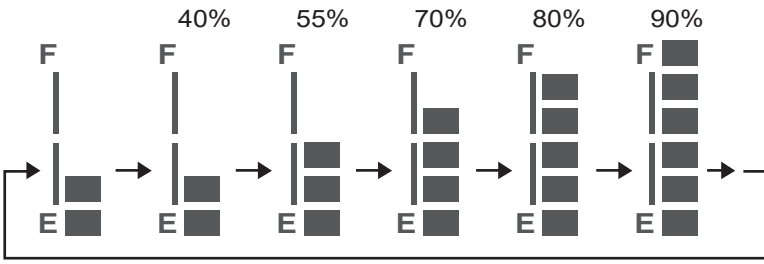
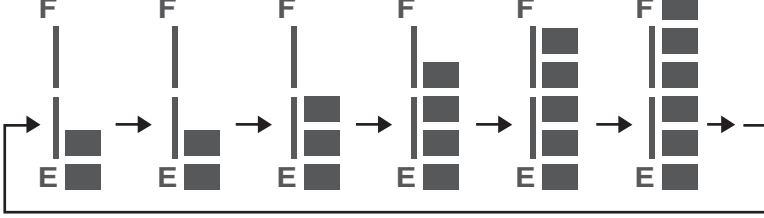
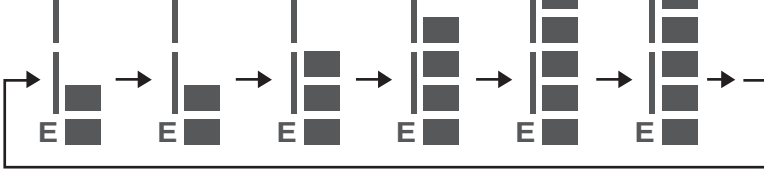
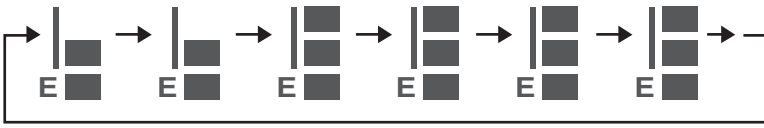
ITEM	DESCRIPTIONS																															
Discharge Capacity	<table border="1" data-bbox="671 1290 1179 1599"> <thead> <tr> <th colspan="2">Capacity (%)</th> <th colspan="3">Status Display</th> </tr> <tr> <th>40%</th> <th>55%</th> <th>70%</th> <th>85%</th> <th>100%</th> </tr> </thead> <tbody> <tr> <td>F</td> <td>F</td> <td>F</td> <td>F</td> <td>F</td> </tr> <tr> <td></td> <td></td> <td></td> <td></td> <td></td> </tr> <tr> <td>E</td> <td>E</td> <td>E</td> <td>E</td> <td>E</td> </tr> </tbody> </table> <table border="1" data-bbox="671 1621 1179 1930"> <tbody> <tr> <td style="text-align: center;">30%</td> </tr> <tr> <td style="text-align: center;">F</td> </tr> <tr> <td style="text-align: center;"></td> </tr> <tr> <td style="text-align: center;">E</td> </tr> <tr> <td style="text-align: center;">← Flashing</td> </tr> <tr> <td>(Status indicator LED will be flashing)</td> </tr> </tbody> </table>	Capacity (%)		Status Display			40%	55%	70%	85%	100%	F	F	F	F	F						E	E	E	E	E	30%	F		E	← Flashing	(Status indicator LED will be flashing)
Capacity (%)		Status Display																														
40%	55%	70%	85%	100%																												
F	F	F	F	F																												
																																
E	E	E	E	E																												
30%																																
F																																
																																
E																																
← Flashing																																
(Status indicator LED will be flashing)																																
Operation Characters	The segments will decrease only, won't increase.																															

Low Voltage Warning Tone	When the battery capacity is lower than 30%, the warning tone will be beeped once with "BiBi – BiBi -- BiBi" 3 short double beeps.
Flicker Frequency	Once per two seconds
Usage Condition	While (1) controller shut down (2) in charging-mode, the function will be disabled.

Charge Status

ITEM	DESCRIPTIONS												
Charge Status	<p>The charging status displays with segments cycling, increasing only, won't decrease.</p> 												
Charging Indicating	<table border="1" style="width: 100%; border-collapse: collapse;"> <thead> <tr> <th style="width: 20%;">Capacity(%)</th> <th style="width: 80%;">Display status of segments</th> </tr> </thead> <tbody> <tr> <td style="text-align: center;">40%</td> <td style="text-align: center;">  </td> </tr> <tr> <td style="text-align: center;">55%</td> <td style="text-align: center;">  </td> </tr> <tr> <td style="text-align: center;">70%</td> <td style="text-align: center;">  </td> </tr> <tr> <td style="text-align: center;">80%</td> <td style="text-align: center;">  </td> </tr> <tr> <td style="text-align: center;">90%</td> <td style="text-align: center;">  </td> </tr> </tbody> </table> <div style="border: 1px solid black; padding: 5px; width: fit-content; margin: 0 auto;"> <p style="text-align: center;">100%</p>  <p style="text-align: center;">displays with 6 segments</p> </div>	Capacity(%)	Display status of segments	40%		55%		70%		80%		90%	
Capacity(%)	Display status of segments												
40%													
55%													
70%													
80%													
90%													
Increasing ratio	0.5 second												
Operation Feature	<p>(1) The segments will increase only, won't decrease.</p> <p>(2) Take PIN3 (CH3) of charger as determinant signal. No matter of KEY ON or KEY OFF, the charging mode will be activated once CH3 is connected to Ground(L)</p> <p>(3) The LCD back light will be ON while any button is pressed. It will light off automatically in 5 seconds if no button has been pressed.</p>												
Remarks	Displayed segments are for reference only. Please refer to indicator of charger for more accurate charging status.												

























































6. Malfunction Messages

ITEM	DESCRIPTIONS																														
Operation Feature	Take the connector pin (KEY) of controller as determinant signal, then converts it into digital codes.																														
Usage Condition	<p>When the controller sends out an error message,  (LED) starts flashing to wait for confirming and display the "Error message code" as follows.</p> <table border="1"> <thead> <tr> <th> flashing</th> <th>LCD code</th> <th>Status</th> </tr> </thead> <tbody> <tr> <td>1</td> <td>Err 1</td> <td>Battery needs charging soon.</td> </tr> <tr> <td>2</td> <td>Err 2</td> <td>Low voltage, needs charging now</td> </tr> <tr> <td>3</td> <td>Err 3</td> <td>Over voltage</td> </tr> <tr> <td>4</td> <td>Err 4</td> <td>Over current</td> </tr> <tr> <td>5</td> <td>Err 5</td> <td>Park Brake is lost or faulted</td> </tr> <tr> <td>6</td> <td>Err 6</td> <td>Accelerator not aligns in center</td> </tr> <tr> <td>7</td> <td>Err 7</td> <td>Accelerator is broken or faulted</td> </tr> <tr> <td>8</td> <td>Err 8</td> <td>Motor is broken or faulted</td> </tr> <tr> <td>9</td> <td>Err 9</td> <td>Others</td> </tr> </tbody> </table>	 flashing	LCD code	Status	1	Err 1	Battery needs charging soon.	2	Err 2	Low voltage, needs charging now	3	Err 3	Over voltage	4	Err 4	Over current	5	Err 5	Park Brake is lost or faulted	6	Err 6	Accelerator not aligns in center	7	Err 7	Accelerator is broken or faulted	8	Err 8	Motor is broken or faulted	9	Err 9	Others
 flashing	LCD code	Status																													
1	Err 1	Battery needs charging soon.																													
2	Err 2	Low voltage, needs charging now																													
3	Err 3	Over voltage																													
4	Err 4	Over current																													
5	Err 5	Park Brake is lost or faulted																													
6	Err 6	Accelerator not aligns in center																													
7	Err 7	Accelerator is broken or faulted																													
8	Err 8	Motor is broken or faulted																													
9	Err 9	Others																													

7. Key On Display

ITEM	DESCRIPTIONS
Initial Status	When scooter power on, the backlight and all LCD segments will be tuned on for 3 seconds, then switch to the default working mode automatically.

8. Warning Tone Setup

ITEM	DESCRIPTIONS																														
Operation Feature	The volume of warning tones of Parking light, Reverse, Horn, Low voltage and Turn signal could be adjusted or turned off. (except you cannot turn off the Horn)																														
	<table border="1"> <thead> <tr> <th>Function</th> <th>Buttons (A+B)</th> <th>Status</th> <th>Initial</th> <th>Volume</th> </tr> </thead> <tbody> <tr> <td>Parking Light Warning Tone</td> <td> + </td> <td>SE7 1</td> <td>Less Loud</td> <td>  >> Increase volume  << Decrease volume </td> </tr> <tr> <td>Reverse Warning Tone</td> <td> + </td> <td>SE7 2</td> <td>Less Loud</td> <td>  Volume </td> </tr> <tr> <td>Volume of Horn</td> <td> + </td> <td>SE7 3</td> <td>Loud</td> <td>  Loud  Less Loud </td> </tr> <tr> <td>Low Voltage Warning Tone</td> <td> + </td> <td>SE7 4</td> <td>Less Loud</td> <td>  Normal  Quiet </td> </tr> <tr> <td>Turn Light Warning Tone</td> <td> + </td> <td>SE7 5</td> <td>Less Loud</td> <td>  Quiet  Silent </td> </tr> </tbody> </table>	Function	Buttons (A+B)	Status	Initial	Volume	Parking Light Warning Tone	 + 	SE7 1	Less Loud	 >> Increase volume  << Decrease volume	Reverse Warning Tone	 + 	SE7 2	Less Loud	 Volume	Volume of Horn	 + 	SE7 3	Loud	 Loud  Less Loud	Low Voltage Warning Tone	 + 	SE7 4	Less Loud	 Normal  Quiet	Turn Light Warning Tone	 + 	SE7 5	Less Loud	 Quiet  Silent
Function	Buttons (A+B)	Status	Initial	Volume																											
Parking Light Warning Tone	 + 	SE7 1	Less Loud	 >> Increase volume  << Decrease volume																											
Reverse Warning Tone	 + 	SE7 2	Less Loud	 Volume																											
Volume of Horn	 + 	SE7 3	Loud	 Loud  Less Loud																											
Low Voltage Warning Tone	 + 	SE7 4	Less Loud	 Normal  Quiet																											
Turn Light Warning Tone	 + 	SE7 5	Less Loud	 Quiet  Silent																											

CAUTION**1. Obstacle Climbing :**

Your scooter can climb obstacles and kerbs of up to 6cm (10cm with run-up for HS-928C) in height. Never attempt to overcome an obstacle when on an uphill or downhill gradient!

Always approach obstacles straight on! Ensure that the front wheels and rear wheels move over the obstacle in one stroke, do not stop halfway!

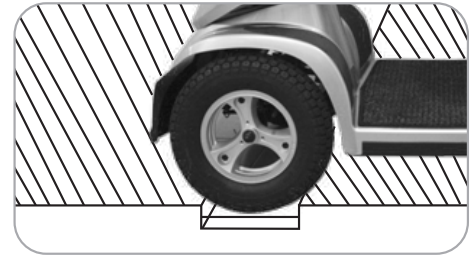
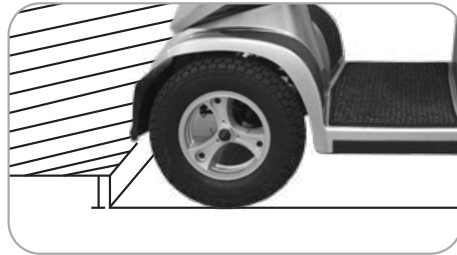
2. The maximum gap the scooter can drive over is 22cm,

- When driving scooter on ramp, adjust body center of gravity to keep scooter more safety.



General driving posture



On ramp, forward your body will let scooter more safety.



In unlikely event of a panel display error, you need to re-set the display system by cycling the on/off main switch. The display circuitry is independent of the motor control system. A display console error does not affect scooter speed control.

OTHER

1. Charge the batteries after each trip, if the scooter is not used for some time batteries must be charged at least once a month. make sure that batteries are fully charged, and on returning, charge them again before using scooter.
2. Check the battery gauge before driving to prevent power depletion.
3. Do not disassemble battery and open sealed parts by yourself to prevent electric shock and burns from acid leakage.
4. Adjust speed to a slow speed when starting off to prevent sudden acceleration.
5. Never attempt to drive downhill backwards.
6. Try not to drive scooter at night or in rain or bad weather.
7. If storing your scooter for a long time (1 month or more), make sure that battery are fully charged, then disconnect the two batteries plugs (W), and store the scooter in a dry, well-ventilated environment. Do not leave the scooter in direct sunlight for prolonged periods. Metal parts and surfaces such as the seat and armrests can become very hot.

CARE AND MAINTENANCE

DAILY CHECK

Please always check your scooter before you start your every journey.

Check point	Inspection	What to do if the inspection is failed
N-D lever	Check for correct function	Contact your dealer.
Horn	Check for correct function	Contact your dealer.
Throttles	Pull the wigwag to test the scooter movement	Contact your dealer.
Electro-mechanical brake and Emergency hand brake	Pull the wigwag a little bit and release it to test if brake works. If your scooter comes with emergency handbrake, please check it as well.	Contact your dealer.
Battery Gauge	Check if the battery gauge is displayed and whether it is at low power.	<ul style="list-style-type: none"> • Contact your dealer if battery gauge is not working. • Recharge the battery immediately if low
Rear mirror (s)	Check if the parts are clean and firmly tighten to the scooter and do not wobble.	<ul style="list-style-type: none"> • Clean up the dirt by damp cloth. • Tighten the screw or clamping stem that holds the mirror(s)
Lighting	Check if all lights, such as head lights, rear lights, and turn signal are functioning correctly.	Contact your dealer.

WEEKLY CHECK

Check point	Inspection	What to do if the inspection is failed
Speed Dial Knob	Check for correct function	Contact your dealer.
Armrests	Check if the parts are clean and firmly tighten to the scooter and do not wobble. Tighten the screw knob that holds the armrest.	Contact your dealer.
Wheels/Tires	Inflate the tire to the correct pressure and check that <ol style="list-style-type: none"> 1. Drive wheels rotate without wobbling. 2. Tire tread depth is not less than 0.5mm. 3. No foreign objects in tires. 	Contact your dealer.
Motor	Check for correct function	Contact your dealer.
Battery Charger	Check if the charger is functioning correctly and the batteries are charged.	Contact your dealer.

MONTHLY CHECK

Check point	Inspection	What to do if the inspection is failed
Seat / Upholstery	Check for movement and if it's worn	Contact your dealer.
Electronics	Check if all the battery cables and connectors are firmly tighten to the scooter	Contact your dealer.

CLEANING YOUR SCOOTER

- Do not use any abrasive or scouring liquids for cleaning. Only use a damp cloth and gentle detergent.
- Do not use hose pipe or splash water directly onto the scooter as this may cause damage to electronics.

MAINTENANCE

- Do not use any abrasive or scouring liquids for cleaning. Only use a damp cloth and gentle detergent.
- Do not use hose pipe or splash water directly onto the scooter as this may cause damage to electronics.

Seat Upholstery :

Only use damp cloth and a little soap to wipe the seat. Do not use abrasive cleaners as this will damage the seat.

Storage :

- Please store the scooter in a dry location. If store the scooter in long time, please disconnect the battery terminals.
- Do not store your scooter where it will be exposed to source of direct heat, damp, oil, acid, alkaline, or where Ozone could be possibly generated. All of the above will minimize scooter / tire cycle and shorten its lifetime.

Tires

User should inspect the tires frequently for damage, the presence of foreign bodies, unusual wear and sufficient tread depth. If replacement tires are needed, please contact the nearest C.T.M. dealer.

Front wheels: 15" air tires.

Rear wheels: 15" air tires.

The following areas require periodic inspection:

- Tire pressure between **2.4-2.8 bar (35-40 psi)**
- Tread depth drops below **1/16"**

Follow these easy steps to replace the tire:

1. Use an ratchet and socket to remove the drive wheel screw from the centre hub of the wheel.
2. Pull the wheel off of the axle.
3. Separate the tire from the rim.
4. Remove the old tire and replace it with a new tire.
5. Slide the wheel back onto the shaft.
6. Install the drive wheel nut into the centre hub and verify the key is lined up with axle and wheel. Then tighten to secure it in place.

All maintenance and repair of scooter should be done by an authorized dealer.

Recycling & Disposal

- The equipment wrapping is potentially recyclable.
- The metal parts are used for scrap metal recycling.
- The plastic parts are used for plastic recycling.
- Electric components and printed circuit boards are disposed of as electronic scrap.
- Exhausted or damaged batteries can be returned to your medical equipment supplier.
- Disposal must be carried out in accordance with the respective national legal provisions.
- Ask your city or district council for details of the local waste management companies.

Service life

We estimate a service life of five years for this product, provided it is used in strict accordance with the intended use as set out in this document and all maintenance and service requirements are met. The estimated service life can be exceeded if the product is carefully used and properly maintained, and provided technical and scientific advances do not result in technical limitations. The service life can also be considerably reduced by extreme or incorrect usage. The fact that we estimate a service life for this product does not constitute an additional warranty.

TECHNICAL SPECIFICATIONS

SPECIFICATIONS	HS-928
Overall Length	1600 mm
Overall Width	720 mm
Overall Height	1280 mm
Front Wheels	380 mm / 15"
Rear Wheels	380 mm / 15"
Weight W/ Batteries	180 kg
Max. Speed	10 kmph
Weight Capacity	230 kg
Ground Clearance	110 mm
Grade Climbable	10 degree
Curb Climbable (W/ run-up)	90 mm / 3.5"
Turning Radius	1860 mm
Min. Turn Around Width	Reversing width 2270 mm ; Pivot width 3470 mm
Suspension	Front & Rear
Brake	Hand Brake & Electro-Mechanical
Seat Type	Swivel Captain Seat With Seat Sliding Mechanism & Back Angle Adjustment
Seat Width	560 mm / 22"
Motor Size	1000W, 3200 r.p.m.
Battery Size	(2) 12V. 100Ah
Weight of Battery	65 kg
Travel Range	50 km / 31 Miles
Battery Charger	12A Off Board
Electronics	On / Off Key Switch, Battery Level Indicator, Speed Control Button

*Subject to change without notice. (Rev. 0, 2020/10/30)

- 1.The travel range is tested according to ISO 7176-4. Range will be affected by external factors, such as the weight of user, status of the batteries, speed setting of scooter, condition of the road, temperature, tire pressure, drive style, and utilization of batteries for lighting, heater, etc.
- 2.The travel range will be 44km without using electric heater. If using the electric heater for the entire journey, the travel range will reduce to 33km.

SERVICE LOG BOOK

YEAR 1

Date: _____

Service Type: _____

Condition Report: _____

Action taken: _____

Inspected By: _____

Signature: _____

YEAR 2

Date: _____

Service Type: _____

Condition Report: _____

Action taken: _____

Inspected By: _____

Signature: _____

YEAR 3

Date: _____

Service Type: _____

Condition Report: _____

Action taken: _____

Inspected By: _____

Signature: _____

YEAR 4

Date: _____

Service Type: _____

Condition Report: _____

Action taken: _____

Inspected By: _____

Signature: _____

YEAR 5

Date: _____

Service Type: _____

Condition Report: _____

Action taken: _____

Inspected By: _____

Signature: _____

YEAR 6

Date: _____

Service Type: _____

Condition Report: _____

Action taken: _____

Inspected By: _____

Signature: _____

YEAR 7

Date: _____

Service Type: _____

Condition Report: _____

Action taken: _____

Inspected By: _____

Signature: _____

YEAR 8

Date: _____

Service Type: _____

Condition Report: _____

Action taken: _____

Inspected By: _____

Signature: _____

YEAR 9

Date: _____

Service Type: _____

Condition Report: _____

Action taken: _____

Inspected By: _____

Signature: _____

YEAR 10

Date: _____

Service Type: _____

Condition Report: _____

Action taken: _____

Inspected By: _____

Signature: _____



MANUFACTURED AND IMPORTED BY:

AIDACARE PTY LTD.

Building 3A, 1 Moorebank Avenue,

Moorebank NSW Australia 2170

1300 133 120 | www.aspirecare.com.au