



USER MANUAL

HS589 MOBILITY SCOOTER MIDI



TABLE OF CONTENTS

INTRODUCTION	1
IMPORTANT PRECAUTIONS	2
ELECTROMAGNETIC INTERFERENCE AND WARNINGS	3
SAFETY WARNING AND INSTRUCTION LABELS	5
IDENTIFICATION OF PARTS	6
OPERATING YOUR SCOOTER	8
DISASSEMBLING YOUR SCOOTER	10
RE-ASSEMBLING YOUR SCOOTER	11
CHARGING THE BATTERIES	11
CARE AND MAINTENANCE	13
OTHER INFORMATION	14
TROUBLE SHOOTING	15
TECHNICAL SPECIFICATIONS	16

INTRODUCTION

Thank you and congratulations on purchasing your new Aspire Mobility Scooter. It is designed to provide you with transportation indoors and outdoors.

Chien Ti Enterprise Co., Ltd. is the manufacturer for the Aspire mobility scooter. We pride ourselves on providing safe and comfortable products. Our goal is to ensure your complete satisfaction with our product. We are certain that you will enjoy your C.T.M. mobility scooter.

Please read and observe all warnings and instructions given in the owner's manual before operating this scooter. Also, retain this booklet for future reference.

MANUFACTURED AND IMPORTED BY:

AIDACARE PTY LTD.

Building 3A, 1 Moorebank Avenue,
Moorebank NSW Australia 2170
1300 133 120 | www.aspirecare.com.au

IMPORTANT PRECAUTIONS

- Only one person at a time could ride an Aspire Mobility Scooter.
- Maximum load is 135 kg / 300 lbs.
- Turn key off before getting on or off.
- Always drive carefully and be aware of others using the same area.
- Always use pedestrian crossings wherever possible. Take extreme care when crossing roads.
- Do not drive on slope exceeding 12 degree, and take extreme care when turning on slope.
- Do not use full power when turning to sharp corner.
- Take great care and drive in low speed when backing up, riding downhill or on uneven surface, and climbing curb.
- Please use the lowest speed when driving through the descending road or uneven terrain. If speed is too fast, leave your hand off the handle bar, let the scooter stop. Make sure safety and start again.
- A slow speed must always be used when ascending, descending or traversing aslope or incline and also on uneven terrain, ramps and soft or loose surfaces, such as gravel or grass.
- To prevent any danger, do not turn around at high speed on ascending, descending ramp.
- Scooter may not operate well in high humidity.
- Do not leave the powered scooter in a rain storm of any kind.
- Do not use the powered scooter in a shower.
- Direct exposure to rain or dampness will cause the scooter to malfunction electrically and mechanically; may cause the powered scooter to prematurely rust.
- Never put scooter in neutral when staying on slopes.
- Follow traffic laws when riding outside.
- When scooter on moving transport vehicles, do not sit or stay on scooter.

ELECTROMAGNETIC INTERFERENCE AND WARNINGS

CAUTION: It is very important that you read this information regarding the possible effects of Electromagnetic Interference on your motorized scooter.

Powered wheelchairs and motorized scooters may be susceptible to electromagnetic interference (EMI), which is interfering electromagnetic energy (EM) emitted from sources such as radio stations, TV stations, amateur radio (HAM) transmitters, two-way radios, and cellular phones. The interference (from radio wave sources) can cause the motorized scooter to release its brakes, move by itself, or move in unintended directions. It can also permanently damage the motorized scooter control system. The intensity of the interfering EM energy can be measured in volts per meter (V/m). Each motorized scooter can resist EMI up to a certain intensity. This is called its "immunity level." The higher the immunity level, the greater the protection will be. At this time, current technology is capable of achieving at least a 20 V/m immunity level, which would provide useful protection from the more common sources of radiated EMI. The immunity level of this motorized scooter model is 10 v/m.

There are a number of sources of relatively intense electromagnetic fields in the everyday environment. Some of these sources are obvious and easy to avoid. Others are not apparent and exposure is unavoidable. However, we believe that by following the warnings listed below, your risk to EMI will be minimized.

The sources of radiated EMI can be broadly classified into three types :

1. Hand-held portable transceivers (transmitters-receivers) with the antenna mounted directly on the transmitting unit. Examples include: citizens band (CB) radios, "walkie talkie," security, fire, and police transceivers, cellular telephones, and other personal communication devices.



Some cellular telephones and similar devices transmit signals while they are ON, even when not being used.

2. Medium-range mobile transceivers, such as those used in police cars, fire trucks, ambulances, and taxis. These usually have the antenna mounted on the outside of the vehicle.

3. Long-range transmitters and transceivers such as commercial broadcast transmitters (radio and TV broadcast antenna towers) and amateur (HAM) radios.



Other types of hand-held devices, such as cordless phones, laptop computers, AM/FM radios, TV sets, CD players, and cassette players, and small appliances, such as electric shavers and hair dryers, so far as we know, are not likely to cause EMI problems to your motorized scooter.

Motorized Scooter Electromagnetic Interference :

Because EM energy rapidly becomes more intense as one moves closer to the transmitting antenna (source), the EM fields from hand-held radio wave sources (transceivers) are of special concern. It is possible to unintentionally bring high levels of EM energy very close to the motorized scooter control system while using these devices. This can affect motorized scooter movement and braking. Therefore, the warnings listed below are recommended to prevent possible interference with the control system of the motorized scooter.

Warnings :

Electromagnetic interference (EMI) from sources such as radio and TV stations, amateur radio (HAM) transmitters, two-way radios, and cellular phones can affect motorized scooters. Following the warnings listed below should reduce the chance of unintended brake release or motorized scooter movement, which could result in serious injury.

1. Do not operate hand-held transceivers (transmitters-receivers), such as citizens band (CB) radios, or turn ON personal communication devices, such as cellular phones, while the motorized scooter is turned ON;
2. Be aware of nearby transmitters, such as radio or TV stations, and try to avoid coming close to them;
3. If unintended movement or brake release occurs, turn the motorized scooter OFF as soon as it is safe;
4. Be aware that adding accessories or components, or modifying the motorized scooter, may make it more susceptible to EMI; and.



There is no easy way to evaluate their effect on the overall immunity of the motorized scooter.

5. Report all incidents of unintended movement or brake release to the distributor listed on the inside front cover of this manual. Note whether there is a source of EMI nearby.

Important Information :

1. 20 volts per meter (V/m) is a generally achievable and useful immunity level against EMI (as of May 1994). The higher the level, the greater the protection.
2. The immunity level of this product is at least 20/Vm.

SAFETY WARNING AND INSTRUCTION LABELS



<p>1</p>	<p>Warning Sticker</p> <ol style="list-style-type: none"> 1. Please read the instruction booklet carefully before using your scooter. 2. Do not drive the scooter on slippery surfaces or on slopes over 10 degrees limit. 3. Do not drive on highway, crowded roads, or unfamiliar areas. 4. Do not turn at high speed in either forward or reverse. 5. Do no wash with water or leave scooter in humid environment since water can damage the electronic parts.
<p>2</p>	<p>Do not hang baggage or other objects on the tiller / tiller adjustment lever.</p>
<p>3</p>	<p>Information Sticker states the date of manufacture and serial number of the scooter. This product has been supplied from an environmentally aware manufacturer. It may contain substances that could be harmful to the environment. Recycling must be carried out in accordance with the respective national legal provisions.</p>
<p>4</p>	<p>Wiring diagram Label</p>
<p>5</p>	<p>N-D Lever Adjustment label which instructs freewheel mode operation.</p>

IDENTIFICATION OF PARTS

Before attempting to drive this scooter on your own, it is important that you familiarize yourself with the controls and how they operate.

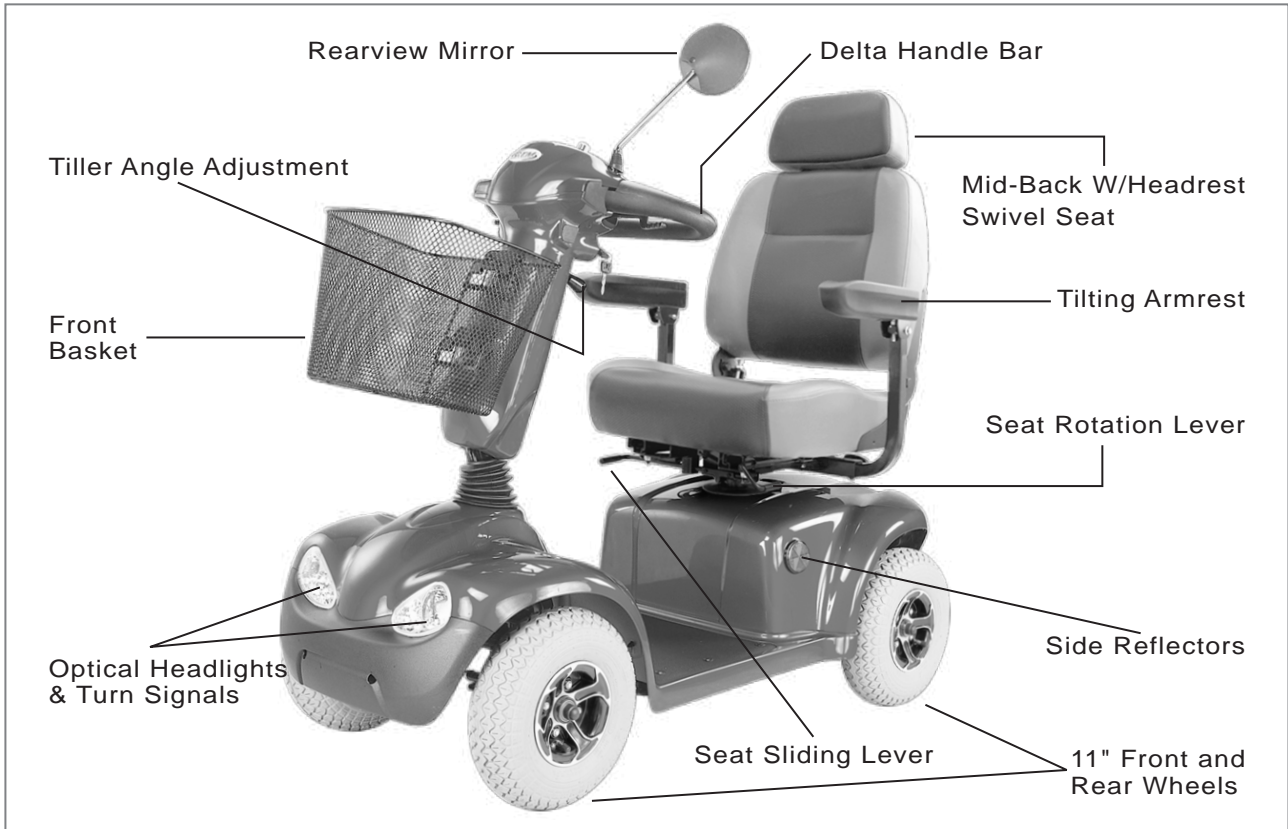

Figure 1 - HS-588 / HS-589 Front View

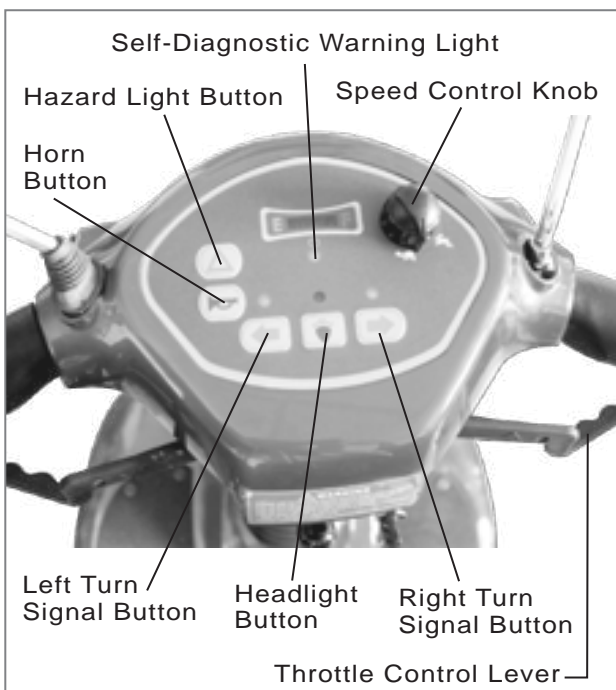

Figure 2 -
HS-588/589 TOP CONTROL PANEL

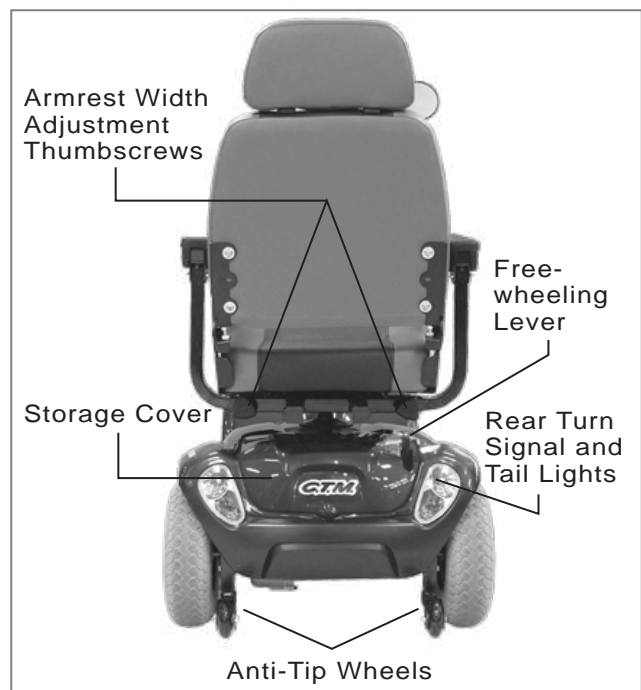
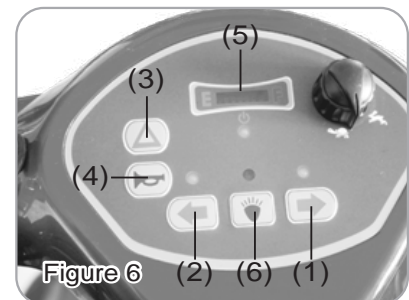
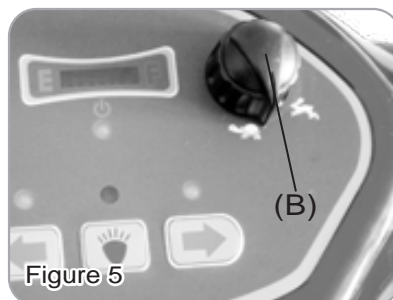
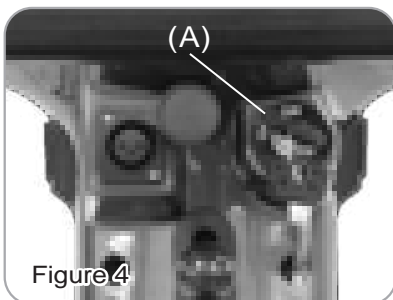

Figure 3
HS-588/589 BACK VIEW

Function Of Parts :

- MAIN SWITCH (A) (See Fig. 4)
 1. Turn the key clockwise to ON to switch power on status.
 2. Turn the key counterclockwise to OFF to switch power off status.
- SPEED CONTROL KNOB (B) (See Fig. 5)
 1. Turn the speed control knob clockwise for faster speed.
 2. Turn the speed control knob counterclockwise for slower speed.
- TOP CONTROL PANEL BUTTONS (See Fig. 6)
 1. Left/Right Turn Signal-Press Right Turn Signal (1) button for turning right, press Left Turn Signal (2) button for turning left.

Right-hand/Left hand direction indicator. (switches itself off automatically after 30 seconds).



2. Hazard Light Button-Press Hazard Light Button (3) to switch on Hazard Light, press the button again to switch off the Hazard Light.
 3. Horn Button-Press Horn Button (4) will buzz warning sound, stop honing by release it.
 4. Power Reserve Indicator (5)-Displays batteries electricity carrying capacity.
 5. Headlight Button-Press Headlight Button (6), headlight will light up.
- THROTTLE CONTROL (See Fig. 7)
 1. Lightly push on the right side throttle control lever (C) to moving forward.
 2. Lightly push on the left side throttle control lever (D) to moving backward.
 3. Release the throttle control lever and the powered scooter will quickly slow down to an immediate stop and the brake will engage.
 4. The throttle control lever can also be operated by fingers in opposite direction.
 - ARMREST ADJUSTMENT (See Fig. 8)
 1. Release Thumbscrew (E), to adjust the armrest's width; tighten to lock in the comfortable desired position.
 - ARM PAD ADJUSTMENT (See Fig. 9)
 1. Adjust the handrail bolt's (F) height, to control the armrest's horizontal angle.

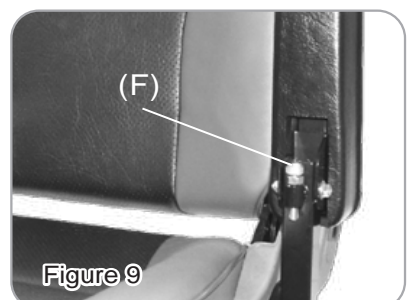
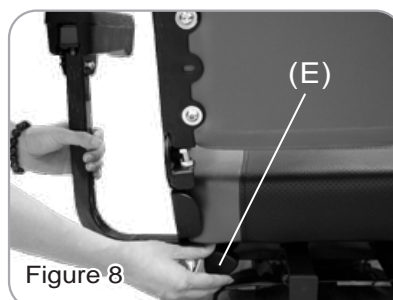
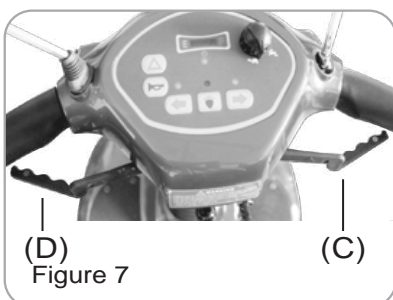

- SEAT ADJUSTMENT (See Fig. 10)
 1. Pull the seat rotation lever (G) up to adjust seat's turning angle, also can lift up the seat.
 2. Pull the seat sliding lever (H) up to adjust the seat to either go forward or backward to an appropriate position.

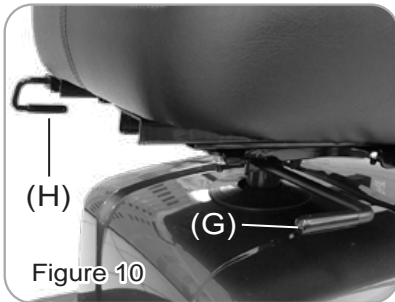

Figure 10

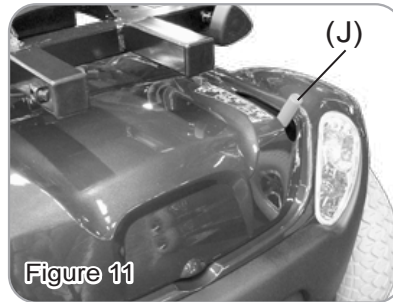

Figure 11

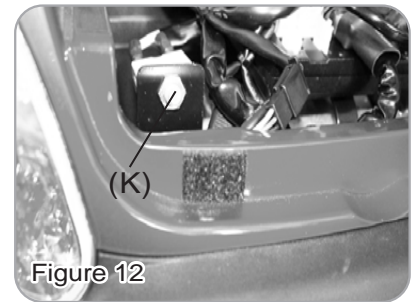

Figure 12

1. The scooter can be pushed manually by pushing the lever forward to N position (J).
2. Before driving, make sure to engage the free-wheeling lever (J) to D position.



Its extremely dangerous and forbidden to drive on the scooter when free-wheeling lever is disengaged and declining a slope.

- CIRCUIT BREAKER (See Fig. 12)
 1. If the scooter's circuit system malfunction or over loaded, the circuit breaker (K) will automatically switch off the power to ensure safety.
 2. After automatically power switch off by press the circuit breaker can be reset.
- TILLER ANGLE ADJUSTMENT (See Fig. 13)
 1. To adjust tiller angle by pushing down the tiller angle adjustment (L).

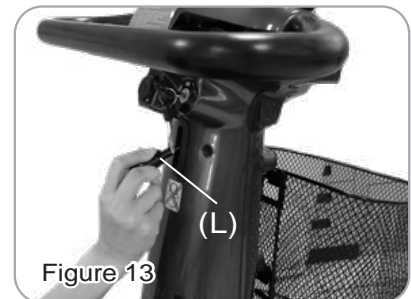

Figure 13



Tiller angle adjustment forbidden to hang any objects.

OPERATING YOUR SCOOTER

Before beginning your journey with your new scooter, make sure that the scooter is on a level surface and clear of any obstacles. Although your scooter is able to climb slopes it is safer to practice on a leveled surface.

You can make the following adjustments to increase your comfort when driving :

- adjust the seat height and location.
 - adjust the armrest width.
 - adjust the tiller to a comfortable position.
1. Before operating your scooter, check the following:
 - the free-wheeling lever is engaged.
 - the speed dial is at the picture of the turtle.
 2. Sit on the scooter and turn on the key. All battery gauge LED lights should be lit. The Self-Diagnostic Warning Light should not be blinking.
 3. When your hands rest comfortably on the handle bar, the thumb control levers should be within reach. The right lever moves the scooter forward; the left one moves it in reverse. When you release the Throttle, the scooter will stop.



This scooter has an automatic braking system. Release the thumb control and the brakes will engage.

4. Steer the scooter by turning the whole tiller in the direction you want to go.
5. Practice driving where there are no obstacles. Start at the slowest speed and drive forward and backward; make some turns. As you get more comfortable you can increase the speed by turning the speed dial toward the picture of the rabbit.

- 6.If only two-battery gauge LED lights are lit, you should plan to recharge the batteries very soon.
- 7.If the scooter stops and does not function, locate the circuit breaker (M) in the storage area. Push it and try the scooter again.
- 8.When you are finished riding, turn off the key before getting off.
- 9.If you are finished riding for the day, immediately recharge the batteries.

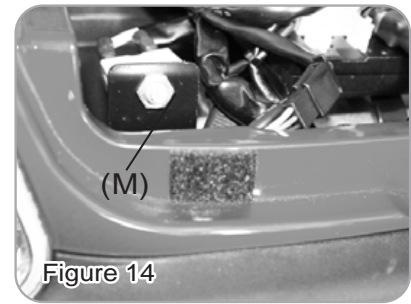

Figure 14

See **CHARGING THE BATTERIES** on page 11.

Keep in mind these rules :

- Release the Throttle and allow the scooter to stop completely before changing from forward to reverse, or reverse to forward.
- When turning a corner, swing the front wheels wide, because the back wheels will turn more tightly.
- Use the scooter only where it would be safe to walk.
- Use low speeds for reverse, downhill, ramps, curbs, or uneven surfaces.

Other Operating Information :

Hill Climbing:You may need to use a higher speed going up on slopes. For a higher speed, set the speed control knob in the proximity of the rabbit.

Down Slopes:To proceed down steep slopes slowly, set the speed control in the proximity of the turtle. This enables driver control, as the closer the speed control is set toward the turtle, the slower the scooter will travel. However, this scooter will not self accelerate down hills due to the automatic braking taking effect should you attempt to drive too fast.

Curb Climbing:Approach slowly at right angles to the curb. A slight angle is permissible with a 4-wheel scooter. Do not attempt curb climbing greater than a 50mm curb. If the Self-Diagnostic Warning Lights start to blink, identify the problem from the chart on page 18 and take action.

Vertical limit approach approximately : 5cm
Acceptable gap width approximately : 22cm



When driving, proceed straight forward slowly pass through the gap.

- When driving scooter on ramp, adjust body center of gravity to keep scooter more safety.

If the scooter breaks down and must be moved, get off the scooter, pull the free-wheeling lever, move the scooter slowly to a safe location, and push the free-wheeling lever back downward to engage.



General driving posture



On ramp, forward your body will let scooter more safety.

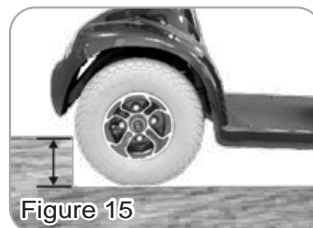

Figure 15

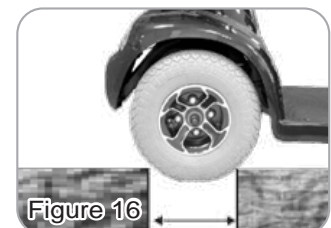

Figure 16



As a safety feature, an automatic speed reducer engages if the scooter is pushed quickly when the Free-Wheeling Lever is disengaged. This standard feature is specifically created for down slopes.

DISASSEMBLING YOUR SCOOTER

Taking apart your scooter enables you to save space when keeping it in storage or to carry it along in your vehicle when going away from home. Having the scooter disassembled is easier than ever since no tools are required. Please follow these steps

Remove the seat by pull the Seat Rotation Lever (N) up and then lift off. (See Fig. 17) Lift up the Storage Cover (O). (See Fig. 18) and detach the Rear Lighting Wiring Harnesses (P). (See Fig. 19) Remove the Rear Shroud (Q) gently which is held by Velcro. (See Fig. 20).

Detach the Main Wiring Harness (R) from the scooter. (See Fig. 21).

Unstrap the Velcro Band (S) that holds the batteries. (See Fig. 22).

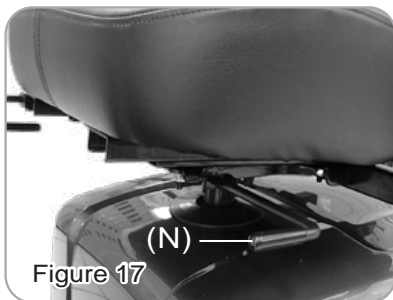

Figure 17

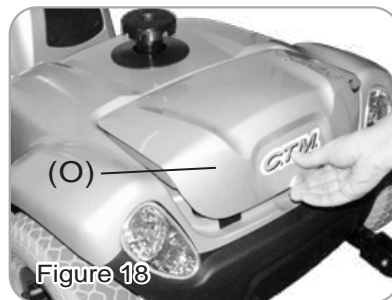

Figure 18

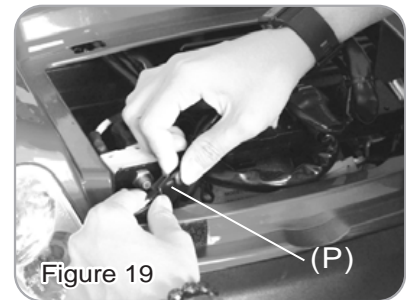

Figure 19

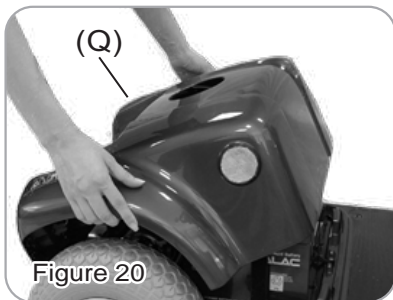

Figure 20

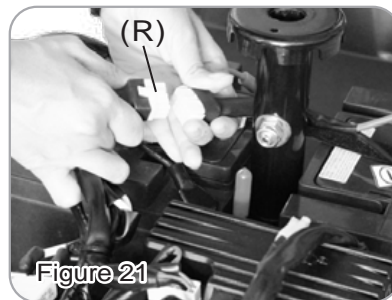

Figure 21

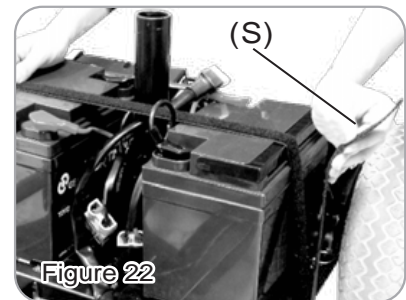

Figure 22

Unplug both Battery Cables (T) and remove the Batteries (U). (See Fig. 23 & 24).

Detach the front and rear sections by holding the Seat Post (V) with one hand and the other hand pushing the release lever to the rear of the scooter. Lift the seat post to separate the Front Frame Assembly (W) from the rear frame assembly. (See Fig. 25).

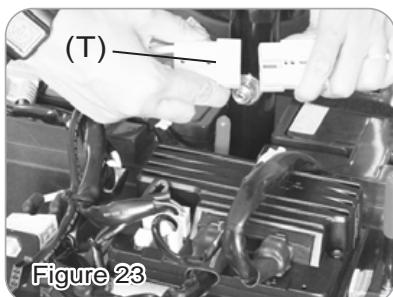

Figure 23

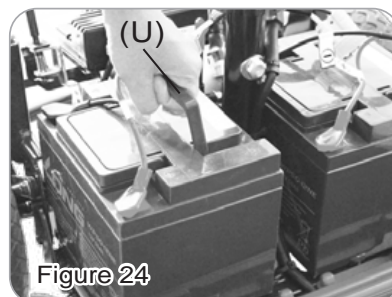

Figure 24

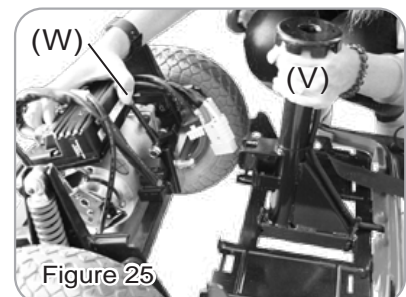

Figure 25

Disassemble Front Basket (X). (See Fig. 26).

Push down the Tiller Angle Adjustment (Y) to fold the tiller in a lower position. (See Fig. 27) Once all the parts have been disassembled, you are now able to put the pieces in storage or in a vehicle for transportation. (See Fig. 28)

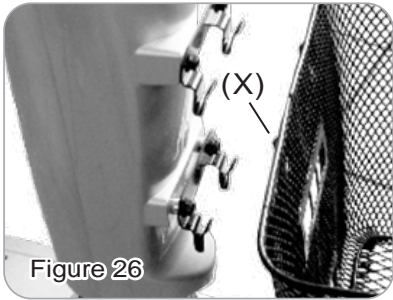

Figure 26

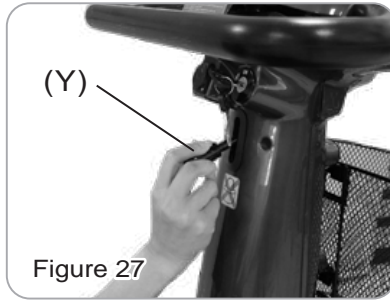

Figure 27

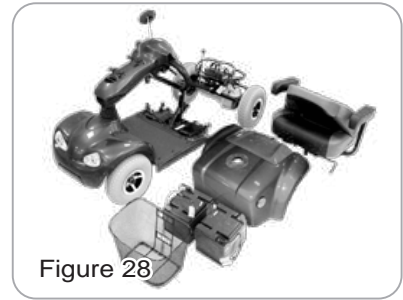

Figure 28

RE-ASSEMBLING YOUR SCOOTER

To assemble the scooter, you can repeat the disassembly directions in reverse. Abbreviated directions are given below. Refer to the figures on pages 12-13 to locate the parts.

1. Using the tiller angle adjustment, unfold the tiller in an upright position. Place the front basket on the tiller.
2. Hold the seat post and align the Curved Locking Brackets (Z) on the front frame assembly with the bar on the rear frame assembly.
3. While holding the seat post, slowly pivot the rear frame assembly forward until the release lever locks.
4. Attach the main wire harness.
5. Place the two batteries and use the Velcro strap to secure them in place.
6. Attach the battery cable plugs.
7. Place the rear shroud on.
8. Attach all rear lighting harnesses.
9. Place the storage cover on.
10. Install the seat by pulling the seat rotation lever up to allow the seat to drop into the locked position.

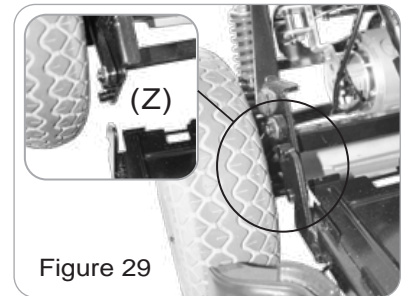

Figure 29

CHARGING THE BATTERIES

Batteries must be charged before using the scooter for the first time and should be recharged after each day use. You will need the scooter and the battery charger.



Each country may supply different charger. The charging procedure may be different from below. If you require more details, please contact your authorized dealer.

Be sure the scooter key is in the OFF position

1. Insert battery charger cord into the charger connector on the charger output. Refer to above figure for correct position.
2. Plug the other end of the battery charger cable into a standard electrical outlet.
3. Turn the power on. Normally, The LED (Power) Light will turn on when electric current passes.

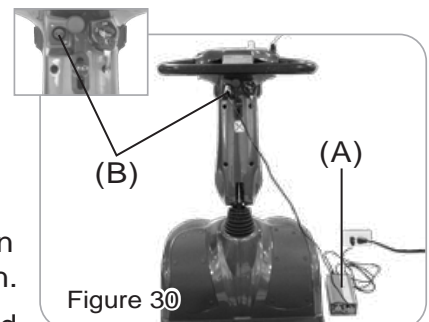

Figure 30

4. Charging starts. During charging, LED (Charge) will indicate orange light, when it turns to green light, that means well-charged.

5. LED indication

- LED(POWER) - GREEN LIGHT ON : Power On.
- LED(CHARGE) - ORANGE LIGHT ON : Charging / GREEN LIGHT ON : Fully Charged

6. Charger Trouble Shooting

(A) If LED (POWER) light is off

- Check the input voltage (115V/230V) is the same as you adjust.
- If light is still off, please check and repair the battery charger.

(B) If LED (CHARGE) light is off

- Check to see clips connection is correct.
- If the battery is fully charged, the LED (CHARGE) light will be off.
- If light is still off, the battery may be defective.

(C) If ORANGE light can turn to GREEN

- The battery can not be charged. Please check and recover it.

(D) If ORANGE light turns to GREEN immediately

- Check to see the battery is fully charged, if not, The battery may be defective. Check and recover it.

Keep in mind these rules :

- Fully charge batteries at least once a month, or more if you use scooter regularly. Charge after each trip exceeding 3 kilometers.
- If storing your scooter for some time (1 month or more), make sure that batteries are fully charged, and on returning, charge them again before using scooter.
- Batteries will only give maximum performance after scooter has been used, and batteries have been recharged up to 10 times. A bit like breaking in a new car.

Please be aware that the travelling range of your mobility scooter is impacted by how fast the batteries are discharged. This will depend on many circumstances, such as ambient temperature, condition of the surface of the road, tyre pressure, weight of the driver, driving environment (inclines etc.) and utilisation of your lighting system if fitted. We recommend that you test your local ride with a family member to ensure a safe journey.



The time needed to recharge will vary depending on the depletion of the batteries. Charging for longer than necessary will not harm the batteries. They cannot be overcharged.

Keep in mind these rules :

- Fully charge batteries at least once a month, more if you use the scooter regularly. Charge after each trip exceeding 3 kilometers / 1.86 miles.
- If storing your scooter for some time (one month or more) make sure that the batteries are fully charged, and on returning, charge them again before using the scooter.

Batteries will only give the maximum performance after the scooter has been used, and the batteries have been recharged up to 10 times.

For safety, please follow the guidelines below.

1. DO NOT use the charger if the power cord is damaged.
2. DO NOT use an extension cord when charging your batteries. A risk of fire and/or electric shock could be encountered.
3. DO NOT take apart the charger, as this will void the warranty.

CARE AND MAINTENANCE

DAILY CHECK

Please always check your scooter before you start your every journey.

Check point	Inspection	What to do if the inspection is failed
N-D lever	Check for correct function	Contact your dealer.
Horn	Check for correct function	Contact your dealer.
Throttles	Pull the wigwag to test the scooter movement	Contact your dealer.
Electro-mechanical brake and Emergency hand brake	Pull the wigwag a little bit and release it to test if brake works. If your scooter comes with emergency handbrake, please check it as well.	Contact your dealer.
Battery Gauge	Check if the battery gauge is displayed and whether it is at low power.	<ul style="list-style-type: none"> • Contact your dealer if battery gauge is not working. • Recharge the battery immediately if low
Rear mirror (s)	Check if the parts are clean and firmly tighten to the scooter and do not wobble.	<ul style="list-style-type: none"> • Clean up the dirt by damp cloth. • Tighten the screw or clamping stem that holds the mirror(s)
Lighting	Check if all lights, such as head lights, rear lights, and turn signal are functioning correctly.	Contact your dealer.

WEEKLY CHECK

Check point	Inspection	What to do if the inspection is failed
Speed Dial Knob	Check for correct function	Contact your dealer.
Armrests	Check if the parts are clean and firmly tighten to the scooter and do not wobble. Tighten the screw knob that holds the armrest.	Contact your dealer.
Wheels/Tires	Inflate the tire to the correct pressure and check that <ol style="list-style-type: none"> 1. Drive wheels rotate without wobbling. 2. Tire tread depth is not less than 0.5mm. 3. No foreign objects in tires. 	Contact your dealer.
Motor	Check for correct function	Contact your dealer.
Battery Charger	Check if the charger is functioning correctly and the batteries are charged.	Contact your dealer.

MONTHLY CHECK

Check point	Inspection	What to do if the inspection is failed
Seat / Upholstery	Check for movement and if it's worn	Contact your dealer.
Electronics	Check if all the battery cables and connectors are firmly tighten to the scooter	Contact your dealer.

Seat Upholstery :

Taking care of your scooter will keep it in top-notch condition. It is recommended that you have your dealer to provide preventative maintenance service of your scooter on a regularly basis. Here are a few maintenance guidelines :

CLEANING YOUR SCOOTER

- Do not use any abrasive or scouring liquids for cleaning. Only use a damp cloth and gentle detergent.
- Do not use hose pipe or splash water directly onto the scooter as this may cause damage to electronics.

MAINTENANCE

- User should inspect the scooter regularly to keep scooter in good running order.
- Check if the electrical cable connectors are fully connected.
- All maintenance and repair of scooter should be done by an authorized dealer.

BODY COVER :

If your scooter is dirty, use a damp or lightly soapy cloth to wipe it down. Do not use running water to wash or rinse the scooter in order to protect the electrical parts. Polish with an automotive liquid polish.

SEAT AND ARMREST :

Only use damp cloth and a little soap to wipe the seat. Do not use abrasive cleaners as this will damage the seat. Please note that using the scooter outdoors can lead to sun damage of the upholstery material. Since this is a normal wear and tear condition, it is not covered under the warranty.

- An authorized dealer should do all maintenance and repair of your scooter that relates to electronics, batteries, motor parts, and tires.

Storage :

- Please store the scooter in a dry location. If store the scooter in long time, please disconnect the battery terminals.
- Do not store your scooter where it will be exposed to source of direct heat, damp, oil, acid, alkaline, or where Ozone could be possibly generated. All of the above will minimize scooter / tire cycle and shorten its lifetime.

OTHER INFORMATION**RECYCLING & DISPOSAL**

- The equipment wrapping is potentially recyclable.
- The metal parts are used for scrap metal recycling. The plastic parts are used for plastic recycling.
- Electric components and printed circuit boards are disposed of as electronic scrap.
- Exhausted or damaged batteries can be returned to your medical equipment supplier.
- Disposal must be carried out in accordance with the respective national legal provisions.
- Ask your city or district council for details of the local waste management companies.

SERVICE LIFE

We estimate a service life of five years for this product, provided it is used in strict accordance with the intended use as set out in this document and all maintenance and service requirements are met. The estimated service can be exceeded if the product is carefully used and properly maintained, and provided technical and scientific advances do not result in technical limitations. The service life can also be considerably reduced by extreme or incorrect usage. The fact that we estimate a service life for this product does not constitute an additional warranty.

TROUBLE SHOOTING

Here are some suggestions about solving problems you may have with your scooter. There is a self-diagnostic warning light on the control panel. To check the self-diagnostic warning light, turn on the key and count the number of blinks on the warning light.

SCOOTER WON'T MOVE WHEN KEY IS TURNED ON

Check point	Solution
Check if the power is off	Turn the power on.
Check if the N-D lever is in Neutral position	Switch to D (drive) position. Turn off the power and turn on again.
Check if the battery power is enough. (Battery gauge is under 25%)	Recharge the battery and then retest.
Check if the charger power cord is still plugged in scooter	Unplug the charger power cord.
1. Check the battery gauge on the control panel. All the LED lights should be on. 2. Check the Self-Diagnostic Warning Light. It should be steady. If it is flashing, see chart below for problem identification. 3. Check all electrical connections to be sure they are tight. 4. If none of these correct the problem, contact your authorized dealer.	

ERROR CODE

Flash	Description	Initial check points
1	Battery Low	The batteries are running low. • Recharge the batteries.
2	Low Battery Fault	The batteries have run out of charge. • Recharge the batteries. • Check the battery and associated connections and wiring.
3	High Battery Fault	Battery voltage is too high. This may occur if overcharged and/or traveling down a long slope. • If traveling down a slope, reduce your speed to minimize the amount of regenerative charging.
4	Current limit time-out or controller overheat	The motor has been exceeding its maximum current rating for too long. • The scooter may have stalled. Turn the controller off, leave for a few minutes and turn back on again. • The motor may be faulty. Check the motor and associated connections and wiring.
5	Park Brake	Either a park brake release switch is active or the park brake is faulty. • Check the park brake and associated connections and wiring. • Ensure any associated switches are in their correct positions.
6	Drive Inhibit	Either a stop function is active or charger inhibits or OONAPU condition has occurred. • Release the stop condition (seat raised etc.) • Disconnect the battery charger. • Ensure the throttle is in Neutral when turning the controller on. • The throttle may require re-calibration.
7	Speed Pot	The throttle, speed limit pot. SRW or their associated wiring may be faulty. • Check the throttle and speed pot and associated connections and wiring.
8	Motor Voltage	The motor or its associated wiring is faulty. • Check the motor and associated connections and wiring.
9	Other Error	The controller may have an internal fault. • Check all connections and wiring.

OTHER PROBLEMS

- If you have charged your scooter for over 10 hours and the light on the charger does not change to green, then please contact your authorized dealer.
- Please note that your scooter is equipped with a controller that constantly checks the drive system for a safe and enjoyable ride. If an error occurs, the control panel will provide you an indication of the problem by way of blinking lights.

TECHNICAL SPECIFICATIONS

Overall Length	1290 mm
Overall Width	625 mm
Overall Height	1150 mm
Front Wheels	290 mm
Rear Wheels	290 mm
Weight W/ Batteries	98 kg
Max. Speed	10 kmph
Weight Capacity	135 kg
Ground Clearance	90 mm
Grade Climbable	15 degree
Curb Climbable	60 mm
Turning Radius	1565 mm
Suspension	Front & Rear
Brake	Electro-Mechanical
Seat Type	Swivel Mid-Back W/ Headrest & Seat Sliding Mechanism
Seat Width	455 mm
Motor Size	700W 5900 r.p.m
Battery Size	(2) 12V. 50Ah
Weight of Battery	30 kg
Travel Range	40 km
Battery Charger	5A Off Board
Electronics	On/Off Key Switch, Battery Level Indicator, Speed Control Knob

*Subject to change without notice. (Rev. 3, 2020/06/29)

The factory settings of this Mobility Scooter, are designed so as to be not capable of a speed exceeding 10km/h on level ground.



MANUFACTURED AND IMPORTED BY:

AIDACARE PTY LTD.

Building 3A, 1 Moorebank Avenue,

Moorebank NSW Australia 2170

1300 133 120 | www.aspirecare.com.au